

INSTYTUT TECHNIKI BUDOWLANEJ
PL 00-611 WARSZAWA
ul. FILTROWA 1
tel.: (48 22) 825-04-71;
(48 22) 825-76-55;
fax: (48 22) 825-52-86;
www.itb.pl

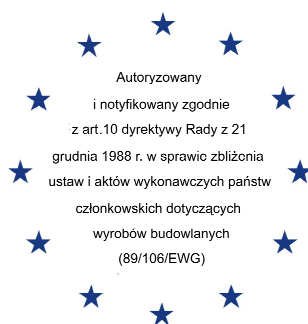

Członek EOTA

European Technical Approval

ETA-11/0479

English language translation - the original version is in Polish language

Nazwa handlowa

Trade name

RAWL R-RB RAWLBOLT

RAWL R-RB RAWLBOLT

Właściciel aprobaty

Holder of approval

RAWLPLUG LIMITED

Thornliebank Industrial Estate

Glasgow G46 8JR

United Kingdom

Rodzaj i przeznaczenie wyrobu

*Generic type and use
of construction products*

Kotwy rozporowe z kontrolowanym momentem dokręcenia o średnicach M6, M8, M10, M12, M16 i M20 do wykonywania zamocowań w betonie niezarysowanym i zarysowanym

Torque controlled expansion anchor of sizes M6, M8, M10, M12, M16 and M20 for use in non-cracked and cracked concrete

Termin ważności

Valid

**od
from
do
to**

30. 03. 2012

30. 03. 2017

Zakład produkcyjny

Manufacturing plant

1 – Zakład produkcyjny nr 2

Manufacturing Plant no. 2

2 – Zakład produkcyjny nr 3

Manufacturing Plant no. 3

Niniejsza Europejska

Aprobata Techniczna zawiera

*This European Technical
Approval contains*

21 stron, w tym 13 Załączników

21 pages including 13 Annexes



Europejska Organizacja ds. Aprobatach Technicznych

European Organisation for Technical Approvals

I LEGAL BASES AND GENERAL CONDITIONS

1. This European Technical Approval is issued by Instytut Techniki Budowlanej in accordance with:
 - Council Directive 89/106/EEC of 21 December 1988 on the approximation of laws, regulations and administrative provisions of Member States relating to construction products¹, amended by the Council Directive 93/68/EEC of 22 July 1993²;
 - ustawa z dnia 16 kwietnia 2004 r. o wyrobach budowlanych (law on construction products from 16th April 2004)³;
 - rozporządzenie Ministra Infrastruktury z dnia 14 października 2004 r. w sprawie europejskich aprobat technicznych oraz polskich jednostek organizacyjnych upoważnionych do ich wydawania (regulation of Ministry of Infrastructure of 14th October 2004 on the European Technical Approvals and Polish bodies entitled to issue them)⁴;
 - Common Procedural Rules for Requesting, Preparing and the Granting of European Technical Approvals set out in the Annex of Commission Decision 94/23/EC⁵;
 - Guideline for European Technical Approval of „*Metal anchors for use in concrete – Part 2: Torque controlled expansion anchors*”, ETAG 001-02.
2. Instytut Techniki Budowlanej is authorized to check whether the provisions of this European Technical Approval are met. Checking may take place in the manufacturing plant. Nevertheless, the responsibility for the conformity of the products to the European Technical Approval and for their fitness for the intended use remains with the holder of the European Technical Approval.
3. This European Technical Approval is not to be transferred to manufacturers or agents of manufacturers other than those indicated on page 1, or manufacturing plants other than those indicated on page 1 of this European Technical Approval.
4. This European Technical Approval may be withdrawn by Instytut Techniki Budowlanej, in particular after information by the Commission on the basis of Article 5 (1) of Council Directive 89/106/EEC.
5. Reproduction of this European Technical Approval including transmission by electronic means shall be in full. However, partial reproduction can be made with the written consent of Instytut Techniki Budowlanej. In this case partial reproduction has to be designated as such. Texts and drawings of advertising brochures shall not contradict or misuse the European Technical Approval.
6. The European Technical Approval is issued by the approval body in its official language. This version corresponds to the version circulated within EOTA. Translations into other languages have to be designated as such.

¹ Official Journal of the European Communities № L 40, 11.02.1989, p. 12

² Official Journal of the European Communities № L 220, 30.08.1993, p. 1

³ Official Journal of Polish Republic № 92/2004, pos. 881

⁴ Official Journal of Polish Republic № 237/2004, pos. 2375

⁵ Official Journal of the European Communities № L 17, 20.01.1994, p. 34

II SPECIFIC CONDITIONS OF THE EUROPEAN TECHNICAL APPROVAL

1 Definition of the product and intended use

1.1 Definition of the product

The RAWL R-RB RAWLBOLT anchors types R-RBL and R-RBP in the sizes M6 to M20 are the anchors made of galvanized steel which are placed into a drill hole and anchored by torque-controlled expansion.

An illustration of the product and intended use are given in Annexes 1, 2 and 3.

1.2 Intended use

The anchor is intended to be used for anchorages for which requirements for mechanical resistance and stability and safety in use in the sense of the Essential Requirements 1 and 4 of Council Directive 89/106/EEC shall be fulfilled and failure of anchorages made with these products would cause risk to human life and/or lead to considerable economic consequences. The anchor is to be used only for anchorages subject to static or quasi-static loading in reinforced or unreinforced normal weight concrete of strength classes C20/25 at minimum and C50/60 at maximum according to EN 206.

The anchor may be anchored in non-cracked and cracked concrete.

The anchor may only be used in structures subject to dry internal conditions.

The anchor may be used for anchorages with requirements related to resistance to fire.

The provisions made in this European Technical Approval are based on an assumed working life of the anchor of 50 years. The indications given on the working life cannot be interpreted as a guarantee given by the producer or Approval Body, but are to be regarded only as a means for choosing the right products in relation to the expected economically reasonable working life of the works.

2 Characteristics of the product and methods of verification

2.1 Characteristics of the product

The anchors correspond to the drawings and provisions given in Annexes 1 to 7. The characteristic material values, dimensions and tolerances of the anchor not given in Annexes 6 to 8 shall correspond to the respective values laid down in the technical documentation⁶ of this European Technical Approval.

Regarding the requirements concerning safety in case of fire it is assumed that the anchor meets the requirements of class A1 in relation to reaction to fire in accordance with the stipulations of the Commission decision 96/603/EC, amended by 2000/605/EC.

⁶ The technical documentation of this European Technical Approval is deposited at the Instytut Techniki Budowlanej and, as far as relevant for the tasks of the approved body involved in the attestation of conformity procedure, is handed over to the approved bodies.

The characteristic values for the design of the anchorages are given in Annexes 10 and 11.

The characteristic values for the design of anchorages regarding resistance to fire are given in Annexes 12 and 13. They are valid for use in a system that is required to provide a specific fire resistance class.

Each anchor is to be marked with identifying mark of the manufacturer and the anchor size according to Annexes 1 and 2.

The anchor shall only be packaged and supplied as a complete unit.

2.2 Methods of verification

The assessment of fitness of the anchor for the intended use in relation to the requirements for mechanical resistance and stability and safety in use in the sense of the Essential Requirement 1 and 4 has been made in accordance with the *Guideline for European Technical Approval of „Metal Anchors for Use in Concrete”, ETAG-001-02, Part 1: “Anchors in general” and Part 2: “Torque-controlled expansion anchors”*, on the basis of Option 1.

The assessment of the anchor for the intended use in relation to the requirements for resistance to fire has been made in accordance with the *Technical Report TR 020 “Evaluation of anchorages in concrete concerning resistance to fire”*.

In addition to the specific clauses relating to dangerous substances contained in this ETA, there may be other requirements applicable to the products falling within its scope (e.g. transposed European legislation and national laws, regulations and administrative provisions). In order to meet the provisions of the Construction Products Directive, these requirements need also to be complied with, when and where they apply.

3 Evaluation and attestation of conformity and CE-marking

3.1 Attestation of conformity system

According to the Decision 96/582/EG of the European Commission⁷ the system 2 (i) (referred to as system 1) of attestation of conformity applies.

This system of attestation of conformity is defined as follows:

System 1: Certification of conformity of the product by an approved certification body on the basis of:

(a) Tasks for the manufacturer:

- (1) factory production control,
- (2) further testing of samples taken at the factory by the manufacturer in accordance with a prescribed test plan,

(b) Tasks for the approved body:

- (3) initial type-testing of the product,
- (4) initial inspection of factory and of factory production control,

⁷ Official Journal of the European Communities L 254 of 08.10.1996

- (5) continuous surveillance, assessment and approval of factory production control.

3.2 Responsibilities

3.2.1 Tasks for the manufacturer

3.2.1.1 Factory production control

The manufacturer shall exercise permanent internal control of production. All the elements, requirements and provisions adopted by the manufacturer shall be documented in a systematic manner in the form of written policies and procedures, including records of results performed. This production control system shall insure that the product is in conformity with this European Technical Approval.

The manufacturer may only use raw materials stated in the technical documentation of this European Technical Approval.

The factory production control shall be in accordance with the control plan⁸ which is part of the technical documentation of this European Technical Approval. The control plan is laid down in the context of the factory production control system operated by the manufacturer and deposited at Instytut Techniki Budowlanej.

The results of factory production control shall be recorded and evaluated in accordance with the provisions of the control plan.

3.2.1.2 Other tasks of manufacturer

The manufacturer shall, on the basis of a contract, involve a body which is approved for the tasks referred to in section 3.1 in the field of anchors in order to undertake the actions laid down in section 3.2.2. For this purpose, the control plan referred to in section 3.2.1.1 and 3.2.2 shall be handed over by the manufacturer to the approved body involved.

The manufacturer shall make a declaration of conformity, stating that the construction product is in conformity with the provisions of this European Technical Approval.

3.2.2 Tasks for the approved bodies

The approved body shall perform the:

- initial type-testing of the product,
- initial inspection of factory and of factory production control,
- continuous surveillance, assessment and approval of factory production control,

in accordance with the provisions laid down in the control plan.

The approved body shall retain the essential points of its actions referred to above and state the results obtained and conclusions drawn in a written report.

The approved certification body involved by the manufacturer shall issue an EC certificate of conformity of the product stating the conformity with the provisions of this European Technical Approval.

⁸ The control plan has been deposited at Instytut Techniki Budowlanej and may be handed over only to the approved body involved in the conformity attestation procedure.

In cases where the provisions of the European Technical Approval and its control plan are no longer fulfilled the certification body shall withdraw the certificate of conformity and inform Instytut Techniki Budowlanej without delay.

3.3 CE-marking

The CE-marking shall be affixed on each packaging of the anchor. The symbol „CE” shall be accompanied by the following information:

- identification number of the approved body,
- the name or identification mark of the producer (legal entity responsible for the manufacture),
- the last two digits of the year in which the CE-marking was affixed,
- the number of the EC certificate of conformity for the product,
- the number of the European Technical Approval,
- the number of the guideline for European Technical Approval,
- use category (ETAG 001-1 Option 1),
- size.

4 Assumptions under which the fitness of the product for the intended use was favorably assessed

4.1 Manufacturing

The European Technical Approval is issued for the product on the basis of agreed data/information, deposited at Instytut Techniki Budowlanej which identifies the product that has been assessed and judged. Changes to the product or production process, which could result in this deposited data/information being incorrect, should be notified to the Instytut Techniki Budowlanej before the changes are introduced. Instytut Techniki Budowlanej will decide whether or not such changes affect the ETA and consequently the validity of the CE marking on the basis of the ETA and if so whether further assessment or alterations to the ETA shall be necessary.

4.2 Design of anchorages

The fitness of the anchor for the intended use is given under the following conditions:

- the anchorages are designed in accordance with the “Guideline for European Technical Approval of Metal Anchors for Use in Concrete”, Annex C, Method A, under the responsibility of an engineer experienced in anchorages and concrete work,
- verifiable calculation notes and drawings are taking account of the loads to be transmitted,
- the position of the anchor is indicated on the design drawings (e.g. position of the anchor relative to reinforcement or to supports in cracked or non-cracked concrete, etc.).

The design of anchorages under fire exposure has to consider the conditions given in the Technical Report TR 020 “Evaluation of anchorages in concrete concerning

resistance to fire". The relevant characteristic anchor values are given in Annexes 12 and 13. The design method covers anchors with a fire attack from one side only. If the fire attack is from more than one side, the design method may be taken only, if the edge distance of the anchor is $c \geq 300$ mm.

4.3 Installation of anchors

The fitness for use of the anchor can only be assumed if the anchor is installed as follows:

- anchor installation carried out by appropriately qualified personnel and under the supervision of the person responsible for technical matters of the site,
- use of the anchor only as supplied by the manufacturer without exchanging any component of the anchor,
- anchor installation in accordance with the manufacturer's specifications and drawings and using the appropriate tools,
- checks before placing the anchor to ensure that the strength class of the concrete in which the anchor is to be placed is in the range given and is not lower than that of the concrete to which the characteristic loads apply,
- check of concrete being well compacted, e.g. without significant voids,
- edge distances and spacings not less than the specified values without minus tolerances,
- positioning of the drill holes without damaging the reinforcement,
- in case of aborted hole: new drilling at a minimum distance away of twice the depth of the aborted hole or smaller distance if the aborted drill hole is filled with high strength mortar and if under shear or oblique tension load it is not in the direction of load application,
- cleaning of the hole of drilling dust,
- anchor installation such that the effective anchorage depth is in accordance with Annex 9,
- application of the torque moment given in Annex 9 using a calibrated torque wrench.

5 Responsibility of the manufacturer

The manufacturer is responsible to ensure that the information on the specific conditions according to 1, 2 and 4 is given to those who are concerned. This information may be made by reproduction of the respective parts of the European Technical Approval. In addition all installation data shall be shown clearly on the package and/or on an enclosed instruction sheet, preferably using illustration(s).

The minimum data required are:

- diameter of drill bit,
- thread diameter,
- maximum thickness of the fixture,
- minimum effective anchorage depth,
- minimum hole depth,

- torque moment,
- information on the installation procedure, including cleaning of the hole, preferably by means of an illustration,
- reference to any special installation equipment needed,
- identification of the manufacturing batch.

All data shall be presented in a clear and explicit form.

On behalf of Instytut Techniki Budowlanej

A handwritten signature in blue ink, appearing to read 'M. Kaproń', is centered below the text 'On behalf of Instytut Techniki Budowlanej'.

Marek Kaproń
Director of ITB

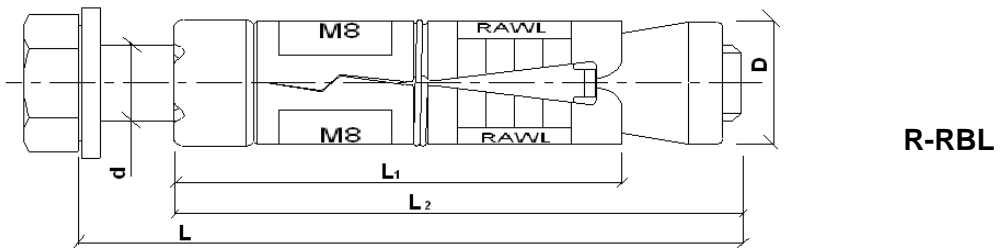
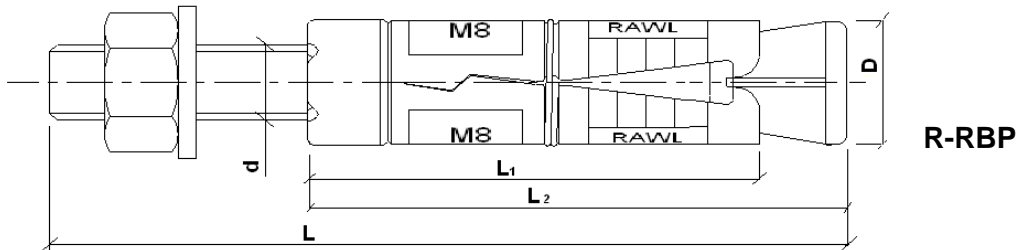

<p>RAWL R-RB RAWLBOLT</p>	<p>Annex 1</p>
<p>Product</p>	<p>of European Technical Approval ETA-11/0479</p>

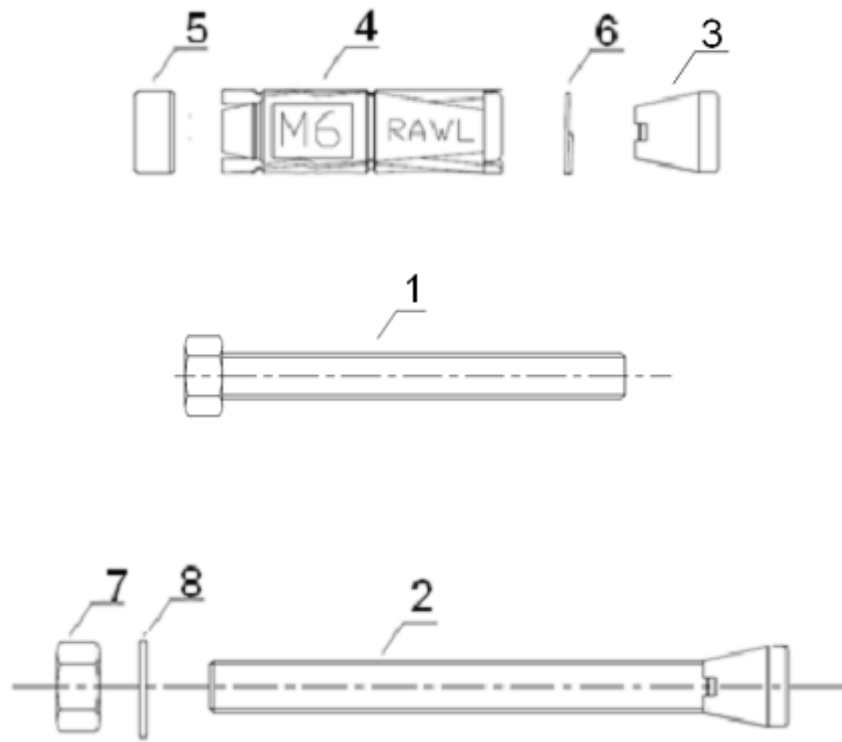

- 1 – screw with hexagonal head,
- 2 – threaded bolt with conical nut,
- 3 – conical nut,
- 4 – expansion sleeve,
- 5, 6 – sleeve fittings,
- 7 – hexagonal nut,
- 8 – washer

RAWL R-RB RAWLBOLT	Annex 2 of European Technical Approval ETA-11/0479
Different parts of the anchor	

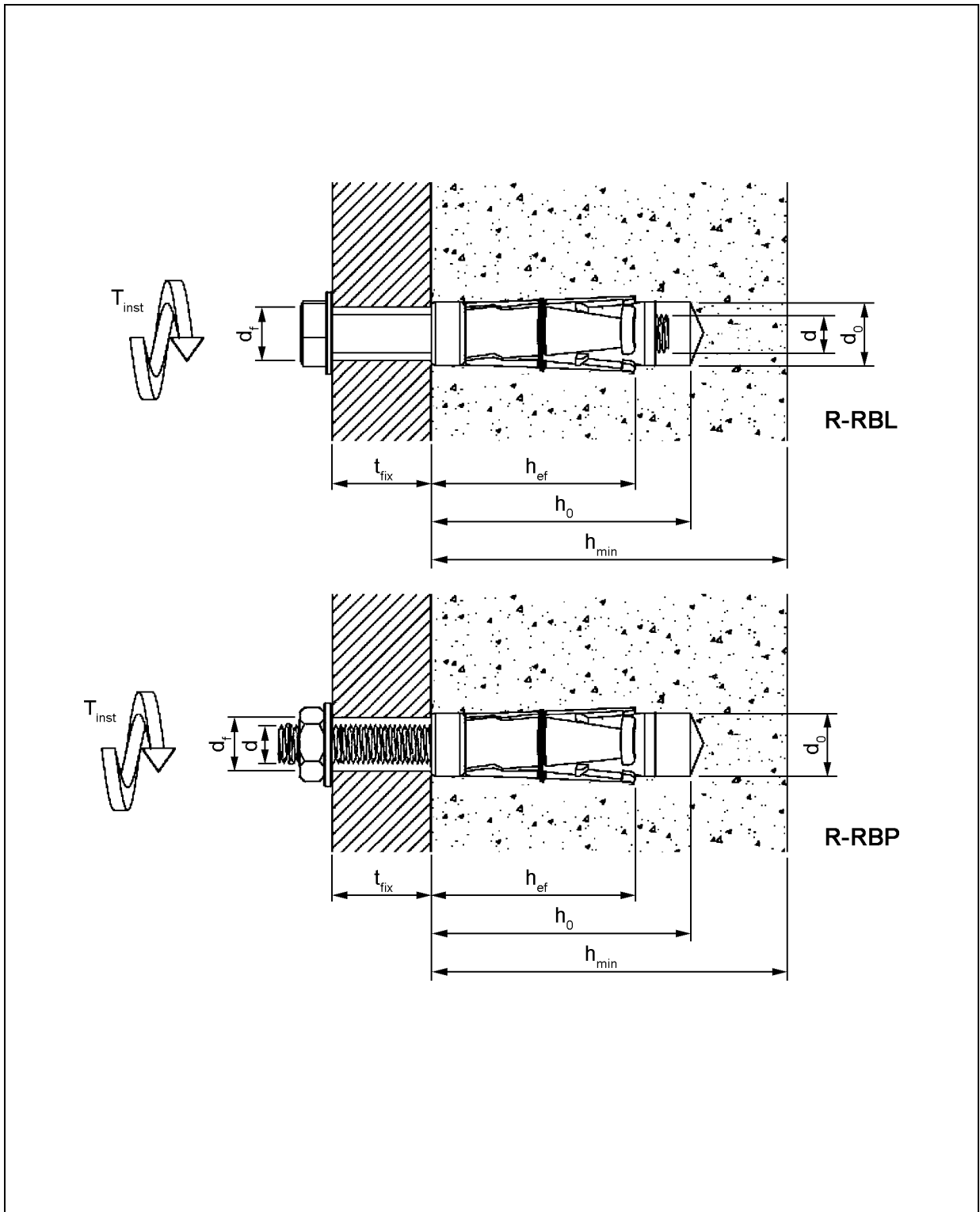

RAWL R-RB RAWLBOLT	Annex 3 of European Technical Approval ETA-11/0479
Intended use	

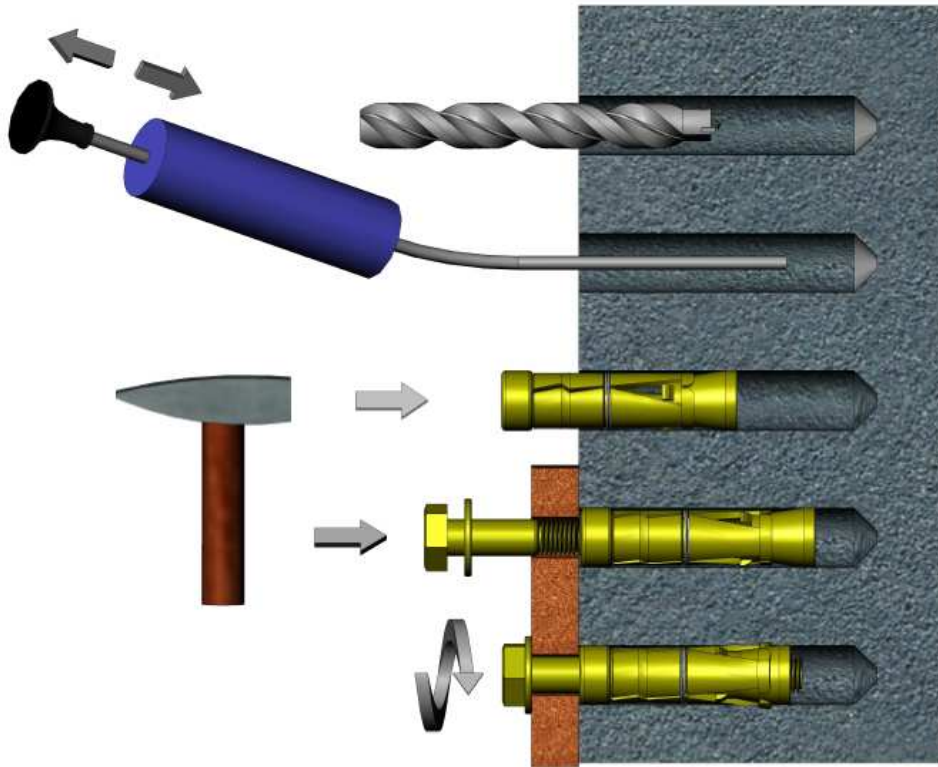

RAWL R-RB RAWLBOLT

Installation instruction for RAWL R-RBL anchor

Annex 4
of European
Technical Approval
ETA-11/0479

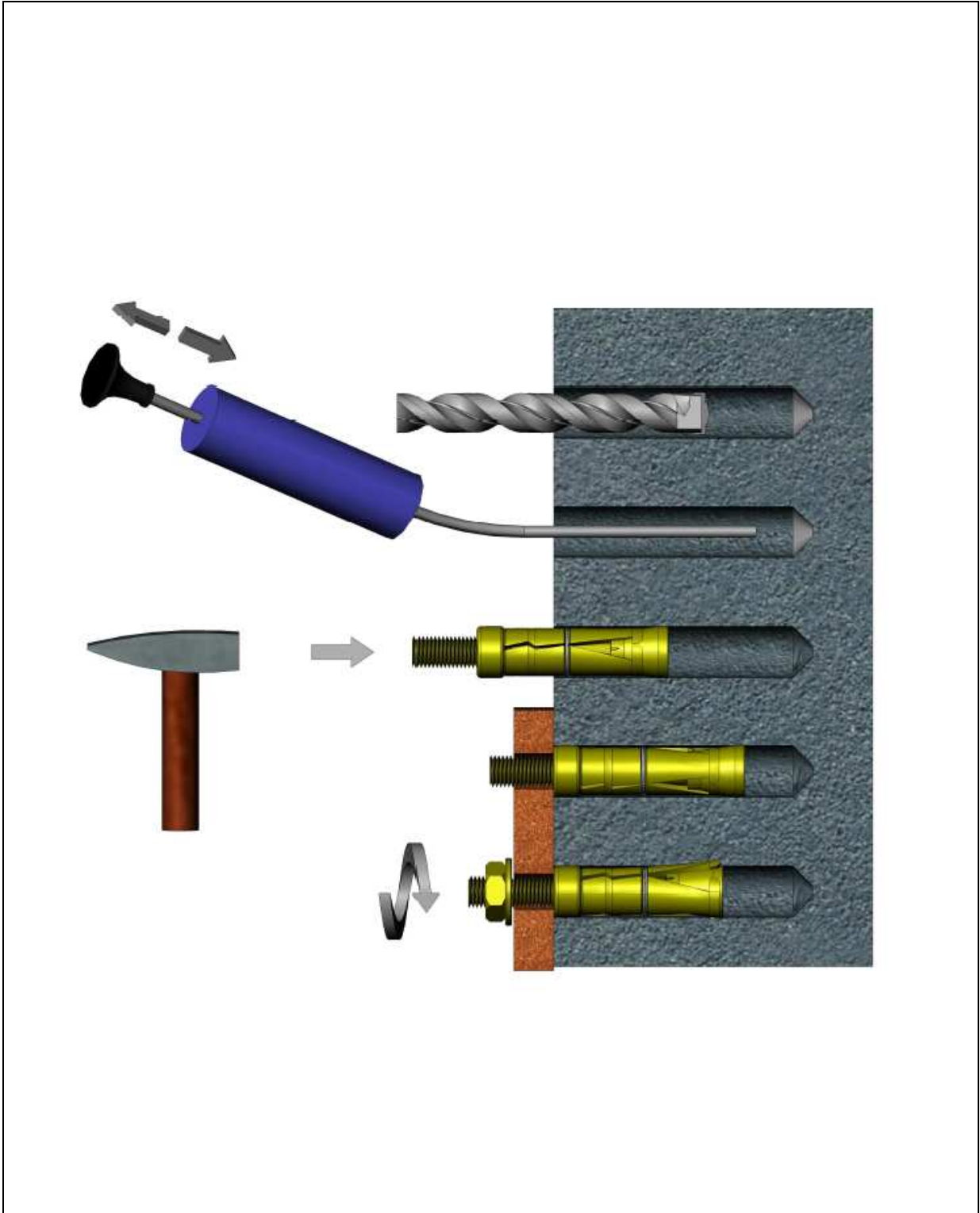

<p>RAWL R-RB RAWLBOLT</p>	<p>Annex 5 of European Technical Approval ETA-11/0479</p>
<p>Installation instruction for RAWL R-RBP anchor</p>	

Table 1: RAWL R-RBL anchor dimensions

Type of anchor			d [mm]	D [mm]	L [mm]	L1 [mm]	L2 [mm]
Size	Marking	t _{fix} ⁽¹⁾ [mm]					
M6	R-RBL-M06/10	10	6	12	55	35	50
	R-RBL-M06/25	25			70		
	R-RBL-M06/40	40			85		
M8	R-RBL-M08/10	10	8	14	65	40	55
	R-RBL-M08/25	25			80		
	R-RBL-M08/40	40			95		
M10	R-RBL-M10/10	10	10	16	75	50	65
	R-RBL-M10/25	25			90		
	R-RBL-M10/50	50			115		
	R-RBL-M10/75	75			140		
M12	R-RBL-M12/10	10	12	20	90	60	85
	R-RBL-M12/25	25			105		
	R-RBL-M12/40	40			120		
	R-RBL-M12/60	60			140		
M16	R-RBL-M16/15	15	16	25	135	95	125
	R-RBL-M16/30	30			150		
	R-RBL-M16/60	60			180		
M20	R-RBL-M20/60	60	20	32	195	115	140
	R-RBL-M20/100	100			235		

⁽¹⁾ – thickness of the fixed element

RAWL R-RB RAWLBOLT	Annex 6 of European Technical Approval ETA-11/0479
Dimensions of RAWL R-RBL anchor	

Table 2: RAWL R-RBP anchor dimensions

Type of anchor			d [mm]	D [mm]	L [mm]	L1 [mm]	L2 [mm]
Size	Marking	t _{fix} ⁽¹⁾ [mm]					
M6	R-RBP-M06/10	10	6	12	65	35	50
	R-RBP-M06/25	25			80		
	R-RBP-M06/60	60			115		
M8	R-RBP-M08/10	10	8	14	75	40	55
	R-RBP-M08/25	25			90		
	R-RBP-M08/60	60			125		
M10	R-RBP-M10/15	15	10	16	90	50	65
	R-RBP-M10/30	30			105		
	R-RBP-M10/60	60			135		
M12	R-RBP-M12/15	15	12	20	110	60	85
	R-RBP-M12/30	30			125		
	R-RBP-M12/75	75			170		
M16	R-RBP-M16/15	15	16	25	150	95	125
	R-RBP-M16/35	35			170		
	R-RBP-M16/75	75			210		
M20	R-RBP-M20/15	15	20	32	170	115	140
	R-RBP-M20/30	30			185		
	R-RBL-M20/100	100			255		

⁽¹⁾ – thickness of the fixed element

RAWL R-RBP RAWLBOLT	Annex 7 of European Technical Approval ETA-11/0479
Dimensions of RAWL R-RBP anchor	

Table 3: Materials

Part	Designation	Material	Protection
1	Screw with hexagonal	Carbon steel class 5.8 EN ISO 898-1	Zinc plated $\geq 5\mu\text{m}$ EN ISO 4042
2	Threaded bolt	Carbon steel class 5.8 EN ISO 898-1	Zinc plated $\geq 5\mu\text{m}$ EN ISO 4042
3	Conical nut	Carbon steel BS 3111-1	Zinc plated $\geq 5\mu\text{m}$ EN ISO 4042
4	Expansion sleeve	Carbon steel BS 1449, Part 1	Zinc plated $\geq 5\mu\text{m}$ EN ISO 4042
5, 6	Sleeve fittings	Carbon steel BS 1449, Part 1	Zinc plated $\geq 5\mu\text{m}$ EN ISO 4042
7	Hexagonal nut	Carbon steel class 5 EN ISO 898-1	Zinc plated $\geq 5\mu\text{m}$ EN ISO 4042
8	Washer	Carbon steel class 5 EN ISO 898-1	Zinc plated $\geq 5\mu\text{m}$ EN ISO 4042

RAWL R-RB RAWLBOLT

Materials

Annex 8
 of European
 Technical Approval
 ETA-11/0479

Table 4: Installation parameters

Anchor size		M6	M8	M10	M12	M16	M20
Effective anchorage depth	h_{ef} [mm]	35	40	50	60	95	115
Nominal drill hole diameter	$d_o =$ [mm]	12	14	16	20	25	32
Depth of drill hole	$h_0 \geq$ [mm]	50	55	65	85	125	140
Diameter of clearance hole in the fixture	$d_f \leq$ [mm]	6,5	9,0	11,0	13,0	17,0	22,0
Installation torque	$T_{inst} =$ [Nm]	6,5	15	27	50	120	230
Minimum thickness of member	h_{min} [mm]	100	100	100	100	142,5	172,5
Minimum spacing	s_{min} [mm]	35	40	50	60	95	115
Minimum edge distance	c_{min} [mm]	52,5	60	75	90	142,5	172,5

RAWL R-RB RAWLBOLT

Installation parameters

Annex 9
 of European
 Technical Approval
 ETA-11/0479

Table 5: Design method A, characteristic values for tension loads

Anchor size		M6	M8	M10	M12	M16	M20
Steel failure							
Characteristic resistance	$N_{Rk,s}$ [kN]	10,05	18,30	29,00	42,15	78,50	122,50
Partial safety factor	$\gamma_{Ms}^{1)}$	1,5					
Pull-out failure							
Characteristic resistance in non-cracked concrete C20/25 – C 50/60	$N_{Rk,p}$ [kN]	6	7,5	12	16	40	50
Characteristic resistance in cracked concrete C20/25 – C 50/60	$N_{Rk,p}$ [kN]	4	5	6	12	16	30
Partial safety factor	$\gamma_{Mp}^{1)}$	1,8 ²⁾					
Concrete cone failure							
Effective anchorage depth	h_{ef} [mm]	35	40	50	60	95	115
Spacing	$s_{cr,N}$ [mm]	105	120	150	180	285	345
Edge distance	$c_{cr,N}$ [mm]	52,5	60	75	90	143	173
Splitting failure							
Spacing	$s_{cr,sp}$ [mm]	105	120	150	180	285	345
Edge distance	$c_{cr,sp}$ [mm]	53	60	75	90	143	173
Partial safety factor	$\gamma_{Msc}^{1)}$	1,8					

¹⁾ – in absence of other national regulations

²⁾ – the partial safety factor $\gamma_2 = 1,2$ included

Table 6: Displacements under tension loads

Anchor size		M6	M8	M10	M12	M16	M20
Tension load	N [kN]	2,52	3,31	6,04	8,73	22,05	32,0
Displacement	δ_{NO} [mm]	0,37	0,35	0,38	0,40	0,81	0,77
	$\delta_{N\infty}$ [mm]	1,00	1,00	1,00	1,00	1,00	1,00

RAWL R-RB RAWLBOLT

Design method A, characteristic values
 for tension loads, displacements

Annex 10
 of European
 Technical Approval
 ETA-11/0479

Table 7: Design method A, characteristic values for shear loads

Anchor size	M6	M8	M10	M12	M16	M20
Steel failure without lever arm						
Characteristic resistance $V_{Rk,s}$ [kN]	5,03	9,15	14,50	21,08	39,25	61,25
Partial safety factor $\gamma_{Ms}^{1)}$	1,25					
Steel failure with lever arm						
Characteristic bending resistance $M^0_{Rk,s}$ [Nm]	7,63	18,74	37,39	65,52	166,52	324,62
Partial safety factor $\gamma_{Ms}^{(1)}$	1,25					
Concrete pryout failure						
Factor in equation (5.6) of ETAG 001 Annex C, 5.2.3.3	1,0			2,0		
Partial safety factor $\gamma_{Mcp}^{1)}$	1,8 ²⁾					
Concrete edge failure						
Effective length of anchor under shear loading l_f [mm]	35	40	50	60	95	115
Effective diameter of anchor d_{nom} [mm]	6	8	10	12	16	20
Partial safety factor $\gamma_{Mc}^{1)}$	1,8					

¹⁾ – in absence of other national regulations

²⁾ – the partial safety factor $\gamma_2 = 1,2$ is included

Table 8: Displacements under tension loads

Anchor size	M6	M8	M10	M12	M16	M20
Shear load V [kN]	3,04	5,51	7,89	11,10	17,84	28,59
Displacement	δ_{v0} [mm]	0,59	2,22	1,15	0,91	0,80
	$\delta_{v\infty}$ [mm]	0,89	3,33	1,73	1,37	1,20

RAWL R-RB RAWLBOLT

Design method A, characteristic values
for shear loads, displacements

Annex 11
of European
Technical Approval
ETA-11/0479

Table 9: Characteristic values of resistance to tension loads under fire exposure

Fire resistance duration = 30 minutes		M6	M8	M10	M12	M16	M20
Characteristic resistance	$N_{Rk,s,fi,30}$ [kN]	0,2	0,4	0,9	1,7	3,1	4,9
Characteristic resistance in concrete C20/25 to C50/60	$N_{Rk,p,fi,30}$ [kN]	1,0	1,3	1,5	3,0	4,0	7,5
Characteristic resistance in concrete C20/25 to C50/60	$N_{Rk,c,fi,30}$ [kN]	1,3	1,8	3,2	5,0	15,7	25,4
Fire resistance duration = 60 minutes		M6	M8	M10	M12	M16	M20
Characteristic resistance	$N_{Rk,s,fi,60}$ [kN]	0,2	0,3	0,8	1,3	2,4	3,7
Characteristic resistance in concrete C20/25 to C50/60	$N_{Rk,p,fi,60}$ [kN]	1,0	1,3	1,5	3,0	4,0	7,5
Characteristic resistance in concrete C20/25 to C50/60	$N_{Rk,c,fi,60}$ [kN]	1,3	1,8	3,2	5,0	15,7	25,4
Fire resistance duration = 90 minutes		M6	M8	M10	M12	M16	M20
Characteristic resistance	$N_{Rk,s,fi,90}$ [kN]	0,1	0,3	0,6	1,1	2,0	3,2
Characteristic resistance in concrete C20/25 to C50/60	$N_{Rk,p,fi,90}$ [kN]	1,0	1,3	1,5	3,0	4,0	7,5
Characteristic resistance in concrete C20/25 to C50/60	$N_{Rk,c,fi,90}$ [kN]	1,3	1,8	3,2	5,0	15,7	25,4
Fire resistance duration = 120 minutes		M6	M8	M10	M12	M16	M20
Characteristic resistance	$N_{Rk,s,fi,120}$ [kN]	0,1	0,2	0,5	0,8	1,6	2,5
Characteristic resistance in concrete C20/25 to C50/60	$N_{Rk,p,fi,120}$ [kN]	0,8	1,0	1,2	2,4	3,2	6,0
Characteristic resistance in concrete C20/25 to C50/60	$N_{Rk,c,fi,120}$ [kN]	1,0	1,4	2,5	4,0	12,6	20,3

		M6	M8	M10	M12	M16	M20
Spacing	$s_{cr,N}$ [mm]	4 x h_{ef}					
	s_{min} [mm]	35	40	50	60	95	115
Edge distance	$c_{cr,N}$ [mm]	2 x h_{ef}					
	c_{min} [mm]	$c_{min} = 2 \times h_{ef}$, however, if the fire attack is from more than one side, the edge distance of the anchor has to be ≥ 300 mm and $\geq 2 \times h_{ef}$					

In absence of other national regulations the partial safety factor for resistance under fire exposure $\gamma_{M,fi} = 1,0$ is recommended

RAWL R-RB RAWLBOLT	Annex 12 of European Technical Approval ETA-11/0479
Characteristic resistance under tension loading with fire exposure	

Table 10: Characteristic values of resistance to shear loads under fire exposure

Fire resistance duration = 30 minutes		M6	M8	M10	M12	M16	M20
Characteristic resistance	$V_{Rk,s,fi,30}$ [kN]	0,2	0,4	0,9	1,7	3,1	4,9
Characteristic bending resistance	$M^0_{Rk,s,fi,30}$ [kN]	0,2	0,4	1,1	2,6	6,7	13,0
Fire resistance duration = 60 minutes		M6	M8	M10	M12	M16	M20
Characteristic resistance	$V_{Rk,s,fi,60}$ [kN]	0,2	0,3	0,8	1,3	2,4	3,7
Characteristic bending resistance	$M^0_{Rk,s,fi,60}$ [kN]	0,1	0,3	1,0	2,0	5,0	9,7
Fire resistance duration = 90 minutes		M6	M8	M10	M12	M16	M20
Characteristic resistance	$V_{Rk,s,fi,90}$ [kN]	0,1	0,3	0,6	1,1	2,0	3,2
Characteristic bending resistance	$M^0_{Rk,s,fi,90}$ [kN]	0,1	0,3	0,7	1,7	4,3	8,4
Fire resistance duration = 120 minutes		M6	M8	M10	M12	M16	M20
Characteristic resistance	$V_{Rk,s,fi,120}$ [kN]	0,1	0,2	0,5	0,8	1,6	2,5
Characteristic bending resistance	$M^0_{Rk,s,fi,120}$ [kN]	0,1	0,2	0,6	1,3	3,3	6,5

M6	M8	M10	M12	M16	M20
-----------	-----------	------------	------------	------------	------------

Concrete pryout failure
 In equation (5.6) of ETAG 001, Annex C, 2.3.3, the k-factor = 2 and the relevant values of $N_{Rk,c,fi}$ above Annex 14, Table 9 have to be considered in the design

Concrete edge failure
 The characteristic resistance $V^0_{Rk,c,fi}$ in concrete C20/25 to C50/60 is determined by:
 $V^0_{Rk,c,fi} = 0,25 \times V^0_{Rk,c}$ (R30, R60, R90) $V^0_{Rk,c,fi} = 0,20 \times V^0_{Rk,c}$ (R120)
 with $V^0_{Rk,c}$ initial value of the characteristic resistance in cracked concrete C20/25 under normal temperature according to ETAG 001, Annex C, 5.5.3.4

In absence of other national regulations the partial safety factor for resistance under fire exposure $\gamma_{M,fi} = 1,0$ is recommended

RAWL R-RB RAWLBOLT	Annex 13 of European Technical Approval ETA-11/0479
Characteristic resistance under shear loading with fire exposure	