

**INSTYTUT TECHNIKI BUDOWLANEJ**  
**PL 00-611 WARSZAWA**  
ul. FILTROWA 1  
tel.: (48 22) 825-04-71;  
(48 22) 825-76-55;  
fax: (48 22) 825-52-86;  
www.itb.pl

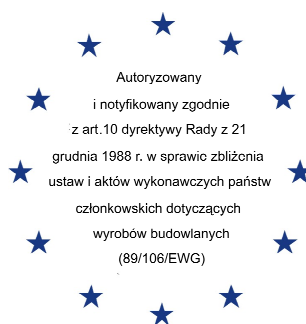

**Członek EOTA**

## European Technical Approval

**ETA-13/0805**

(English language translation – the original version is in Polish language)

<b>Nazwa handlowa</b> <i>Trade name</i>	<b>R-KER / RV200, R-KER-W / RV200-W i R-KER-S / RV200-S</b> <i>R-KER / RV200, R-KER-W / RV200-W and R-KER-S / RV200-S</i>
<b>Właściciel aprobaty</b> <i>Holder of approval</i>	<b>RAWLPLUG S.A</b> <b>ul. Kwidzyńska 6</b> <b>51-416 Wrocław</b> <b>Polska</b>
<b>Rodzaj i przeznaczenie wyrobu</b> <i>Generic type and use of construction products</i>	<b>Kotwy wklejane z tulejami z gwintem wewnętrznym i prętami zbrojeniowymi o średnicach Ø8 do Ø32 do wykonywania zamocowań w betonie niezarysowanym</b> <i>Bonded anchor with internal sleeves and rebars of sizes Ø8 to Ø32 for use in non-cracked concrete</i>
<b>Termin ważności</b> <i>Valid</i>	<b>od</b> <i>from</i> <b>27. 06. 2013</b> <b>do</b> <i>to</i> <b>19. 06. 2018</b>
<b>Zakład produkcyjny</b> <i>Manufacturing plant</i>	<b>Zakład Produkcyjny nr 3</b> <i>Manufacturing Plant no. 3</i>
<b>Niniejsza Europejska Aprobata Techniczna zawiera</b> <i>This European Technical Approval contains</i>	<b>24 strony, w tym 15 Załączników</b> <i>24 pages including 15 Annexes</i>
<b>Niniejsza Europejska Aprobata Techniczna zastępuje</b> <i>This European Technical Approval replaces</i>	<b>ETA-13/0805 ważną od 19.06.2013 do 19.06.2018</b> <i>ETA-13/0805 with validity from 19.06.2013 to 19.06.2018</i>



Europejska Organizacja ds. Aprobatach Technicznych  
European Organisation for Technical Approvals

## I LEGAL BASES AND GENERAL CONDITIONS

1. This European Technical Approval is issued by Instytut Techniki Budowlanej in accordance with:
  - Council Directive 89/106/EEC of 21 December 1988 on the approximation of laws, regulations and administrative provisions of Member States relating to construction products<sup>1</sup>, amended by the Council Directive 93/68/EEC of 22 July 1993<sup>2</sup>;
  - ustawa z dnia 16 kwietnia 2004 r. o wyrobach budowlanych (law on construction products from 16<sup>th</sup> April 2004)<sup>3</sup>;
  - rozporządzenie Ministra Infrastruktury z dnia 14 października 2004 r. w sprawie europejskich aprobat technicznych oraz polskich jednostek organizacyjnych upoważnionych do ich wydawania (regulation of the Ministry of Infrastructure of 14<sup>th</sup> October 2004 on the European Technical Approvals and Polish bodies entitled to issue them)<sup>4</sup>;
  - Common Procedural Rules for Requesting, Preparing and the Granting of European Technical Approvals set out in the Annex of Commission Decision 94/23/EC<sup>5</sup>;
  - Guideline for European Technical Approval of “*Metal anchors for use in concrete – Part 5: Bonded anchors*”, ETAG 001-05;
2. Instytut Techniki Budowlanej is authorized to check whether the provisions of this European Technical Approval are met. Checking may take place in the manufacturing plant. Nevertheless, the responsibility for the conformity of the products to the European Technical Approval and for their fitness for the intended use remains with the holder of the European Technical Approval.
3. This European Technical Approval is not to be transferred to manufacturers or agents of manufacturers other than those indicated on page 1, or manufacturing plants other than those indicated on page 1 of this European Technical Approval.
4. This European Technical Approval may be withdrawn by Instytut Techniki Budowlanej, in particular after information by the Commission on the basis of Article 5(1) of Council Directive 89/106/EEC.
5. Reproduction of this European Technical Approval including transmission by electronic means shall be in full. However, partial reproduction can be made with the written consent of Instytut Techniki Budowlanej. In this case partial reproduction has to be designated as such. Texts and drawings of advertising brochures shall not contradict or misuse the European Technical Approval.
6. The European Technical Approval is issued by the approval body in its official language. This version corresponds to the version circulated within EOTA. Translations into other languages have to be designated as such.

---

<sup>1</sup> Official Journal of the European Communities № L 40, 11.02.1989, p. 12

<sup>2</sup> Official Journal of the European Communities № L 220, 30.08.1993, p. 1

<sup>3</sup> Official Journal of Polish Republic № 92/2004, pos. 881

<sup>4</sup> Official Journal of Polish Republic № 237/2004, pos. 2375

<sup>5</sup> Official Journal of the European Communities № L 17, 20.01.1994, p. 34

## **II SPECIFIC CONDITIONS OF THE EUROPEAN TECHNICAL APPROVAL**

### **1 Definition of product and intended use**

#### **1.1 Definition of product**

The subject of this European Technical Approval are the bonded anchors (injection type) consisting of the injection mortar R-KER / RV200, R-KER-W / RV200-W or R-KER-S / RV200-S cartridge using an applicator gun equipped with a special mixing nozzle and metal element. The element is made of zinc coated steel or stainless steel (internal sleeves) or steel reinforcing bars.

The metal element is placed into a drilled hole previously cleaned and filled with injection mortar. The metal element is anchored by the bond between element, injection mortar and concrete.

The mortar cartridges are available in different sizes: 150 ml to 825 ml and types: two part foil capsules in one cartridge, coaxial cartridge, side by side cartridge or foil capsules.

An illustration of the product and intended use are given in Annexes 1 to 5.

#### **1.2 Intended use**

The anchors are intended to be used for anchorages for which requirements for mechanical resistance and stability and safety in use in the sense of the Essential Requirements 1 and 4 of Council Directive 89/106/EEC shall be fulfilled and failure of anchorages made with these products would compromise the stability of the works, cause risk to human life and/or lead to considerable economic consequences. Safety in the case of fire (Essential Requirement 2) is not covered by this ETA. The anchors are to be used only for anchorages subject to static or quasi-static loading in reinforced or unreinforced normal weight concrete of strength class C20/25 at minimum to C50/60 at maximum according to EN 206-1.

The anchors may be used in non-cracked concrete only.

The anchors may be installed in dry or wet concrete (use category 1) or in flooded holes with the exception of seawater (use category 2).

The anchors may be used in the following temperature range:

- a) -40°C to +40°C (max. short term temperature +40° C and max. long term temperature +24°C),
- b) -40°C to +80°C (max. short term temperature +80° C and max. long term temperature +50°C).

Elements made of zinc coated steel (electroplated or hot-dipped galvanized) may be used in structures subject to dry internal conditions only.

Elements made of stainless steel may be used in structures subject to dry internal conditions and also in structures subject to external atmospheric exposure (including industrial and marine environment) or exposure in permanently damp internal conditions if no particular aggressive conditions exist. Such particular aggressive conditions are e.g. permanent, alternating immersion in seawater or the splash zone

of seawater, chloride atmosphere of indoor swimming pools or atmosphere with extreme chemical pollution (e.g. in desulphurization plants or road tunnels where de-icing materials are used).

Elements made of reinforcing bars may be used as anchors designed in accordance with the EOTA Technical Report TR 029 only. Such applications are e.g. concrete overlay or shear dowel connections or the connections of a wall predominantly loaded by shear and compression forces with the foundation, where the reinforcing bars act as dowels to take up shear forces. Connections with the post-installed reinforcing bars in concrete structures designed in accordance with EN 1992-1-1 (Eurocode 2) are not covered by this European Technical Approval.

The provisions made in this European Technical Approval are based on an assumed intended working life of the anchor of 50 years. The indications given on the working life cannot be interpreted as a guarantee given by the producer or Approval Body, but are to be regarded only as a means for choosing the right products in relation to the expected economically reasonable working life of the works.

## **2 Characteristics of product and methods of verification**

### **2.1 Characteristics of product**

The anchors and the mortar cartridges correspond to the drawings and provisions given in Annexes 1 to 3. The characteristic material values, dimensions and tolerances of the anchors not indicated in Annexes shall correspond to the respective values laid down in the technical documentation<sup>6</sup> of this European Technical Approval.

The characteristic values for the design of anchorages are given in Annexes 10 to 15.

The two components of the injection mortar are delivered in unmixed condition in mortar cartridges of a size 150 to 600 ml in the case of two part foil capsules in the cartridge, 345 to 825 ml in the case of side by side cartridge, 150 to 410 ml in the case of coaxial cartridge and 150 to 600 ml in the case of foil capsule, in accordance with Annexes 2 and 3.

The injection mortar delivered in two part foil capsules in the cartridge, side by side cartridges or coaxial cartridge bears the trade name R-KER, RAWL R-KER-W or R-KER-S. The injection mortar delivered in foil capsule bears the trade name RV200, RV200-W or RV200-S.

Each mortar cartridge or foil capsule is marked with the identifying mark of the producer and the trade name in accordance with Annex 2 or 3.

Each internal sleeve is marked in accordance with Annex 1.

Elements made of reinforcing bars shall comply with the specification given in Annex 7.

The marking of embedment depth may be done on a job site.

---

<sup>6</sup> The technical documentation of this European Technical Approval is deposited at Instytut Techniki Budowlanej and, as far as relevant for the tasks of the approved body involved in the attestation of conformity procedure, may be handed over only to the approved body involved.

## **2.2 Methods of verification**

The assessment of fitness of the anchors for the intended use in relation to the requirements for mechanical resistance and stability and safety in use in the sense of the Essential Requirements 1 and 4 has been made in accordance with the ETAG 001 Guideline for European Technical Approvals of “*Metal anchors for use in concrete*”, Part 1: “*Anchors in general*” and Part 5: “*Bonded anchors*”, on the basis of Option 7.

In addition to the specific clauses relating to dangerous substances contained in this European Technical Approval, there may be other requirements applicable to the products falling within its scope (e.g. transposed European legislation and national laws, regulations and administrative provisions). In order to meet the provisions of the Construction Products Directive, these requirements need also to be complied with, when and where they apply.

## **3 Evaluation of Conformity and CE marking**

### **3.1 System of attestation of conformity**

The system of attestation of conformity 2 (i) (referred to as system 1) according to Council Directive 89/106/EEC Annex III laid down by the European Commission provides:

(a) Tasks of the manufacturer:

- 1) factory production control,
- 2) further testing of samples taken at the factory by the manufacturer in accordance with a prescribed test plan;

(b) Tasks of the approved body:

- 3) initial type-testing of the product,
- 4) initial inspection of factory and of factory production control,
- 5) continuous surveillance, assessment and approval of factory production control.

### **3.2 Responsibilities**

#### **3.2.1 Tasks of the manufacturer**

##### **3.2.1.1. Factory production control**

The manufacturer shall exercise permanent internal control of production. All the elements, requirements and provisions adopted by the manufacturer shall be documented in a systematic manner in the form of written policies and procedures. This production control system shall ensure that the product is in conformity with the European Technical Approval.

The manufacturer shall only use raw materials stated in the technical documentation of this European Technical Approval.

The factory production control shall be in accordance with the control plan<sup>7</sup> which is a part of the technical documentation of this European Technical Approval. The

---

<sup>7</sup> The control plan is a confidential part of the European Technical Approval and may be handed over only to the approved body involved in the attestation of conformity procedure.

control plan is laid down in the context of the factory production control system operated by the manufacturer and deposited at Instytut Techniki Budowlanej.

The results of factory production control shall be recorded and evaluated in accordance with the provisions of the control plan.

#### 3.2.1.2. Other task of the manufacturer

The manufacturer shall, on the basis of the contract, involve a body which is approved for the tasks referred to in section 3.1 in the field of anchors in order to undertake the actions laid down in section 3.2.2. For this purpose, the control plan referred to in section 3.2.1.1 and 3.2.2 shall be handed over by the manufacturer to the approved body involved.

The manufacturer shall make a declaration of conformity, stating that the construction product is in conformity with the provision of this European Technical Approval.

### 3.2.2 Tasks of the approved body

#### 3.2.2.1 Initial type-testing of the product

For initial type-testing the results of the tests performed as part of the assessment for the European Technical Approval shall be used unless there are changes in the production line or plant. In such cases the necessary initial type-testing has to be agreed between the Instytut Techniki Budowlanej and the approved body involved.

#### 3.2.2.2 Initial inspection of factory and of factory production control

The approved body shall ascertain that, in accordance with the control plan, the factory, in particular the staff and equipment, and the factory production control are suitable to ensure continuous and orderly manufacturing of the anchor according to the specifications mentioned in clause 2.1 as well as to the Annexes to this European Technical Approval.

#### 3.2.2.3 Continuous surveillance

Continuous surveillance and assessment of factory production control have to be performed according to the control plan.

The approved body shall visit the factory at least once a year for surveillance. It has to be verified that the system of factory production control and the specified automated manufacturing process are maintained taking account of the control plan.

The results of continuous surveillance shall be made available on demand by the approved body to Instytut Techniki Budowlanej. In cases where the provisions of the European Technical Approval and the control plan are no longer fulfilled the conformity certificate shall be withdrawn.

### 3.3 CE-marking

The CE marking shall be affixed on each packaging of the anchors. The letters "CE" shall be accompanied by the following information:

- identification number of the approved body,
- name and address of the producer (legal entity responsible for the manufacture),
- last two digits of the year in which the CE marking was affixed,
- number of the EC certificate of conformity,
- number of the European Technical Approval,

- number of the guideline for the European Technical Approval,
- use category (ETAG 001-01, Option 7),
- size.

## **4 Assumptions under which the fitness of the product for the intended use was favourably assessed**

### **4.1 Manufacturing**

The European Technical Approval is issued on the basis of agreed data/information, deposited with Instytut Techniki Budowlanej which identifies the product that has been assessed and judged. Changes to the product or production process, which could result in this deposited data/information being incorrect, should be notified to Instytut Techniki Budowlanej before the changes are introduced. Instytut Techniki Budowlanej will decide whether or not such changes affect the ETA and consequently the validity of the CE marking on the basis of the ETA and if so whether further assessment or alterations to the ETA shall be necessary.

### **4.2 Design of anchorages**

The fitness of the anchors for the intended use is given under the following conditions.

The anchorages are designed in accordance with EOTA Technical Report TR 029 “Design of bonded anchors” under the responsibility of an engineer experienced in anchorages and concrete work.

Post-installed reinforcing bars may be used as anchor designed in accordance with the EOTA Technical Report 029 only. The basic assumptions for the design according to anchor theory shall be observed. This includes the consideration of tension and shear loads and the corresponding failure modes. Such applications are e.g. concrete overlay or shear dowel connections or the connection of the wall predominantly loaded by shear and compression forces with the foundation, where the reinforcing bars act as dowels to take up shear forces. Connections with reinforcing bars in concrete structures designed in accordance with EN 1992-1-1, are not covered by this European Technical Approval.

For the internal sleeve material and required strength class of the threaded rod or fastening screw shall be specified in accordance with Annex 7. The minimum and maximum thread engagement length  $h_s$  of the threaded rod or fastening screw for the installation of the fixture shall meet the requirements according to Annex 4. The length of the threaded rod shall be determined depending on thickness of the fixture, admissible tolerances, available thread length and minimum and maximum thread engagement length  $h_s$ .

Verifiable calculation notes and drawings are prepared taking account of the loads to be anchored.

The position of the anchor is indicated on the design drawings (e.g. position of the anchor relative to reinforcement or to support, etc.).

### 4.3 Installation of the anchors

The fitness for use of the anchors can only be assumed if the anchors are installed as follows:

- anchors installation carried out by appropriately qualified personnel and under the supervision of the person responsible for technical matters on the site,
- anchors installation in accordance with manufacturer's specifications and drawings using the tools indicated in the technical documentation of this European Technical Approval,
- use of the anchor only as supplied by the manufacturer without exchanging the components of an anchor,
- use of the commercial standard threaded rods (in the case of rods made of galvanized steel – standard rods of the strength class  $\leq 8.8$  only), washers and hexagonal nuts under the following requirements:
  - material, dimensions and mechanical properties of the metal parts according to the specifications given in Annex 7,
  - confirmation of material and mechanical properties of the metal parts by inspection certificate 3.1 according to EN-10204:2004; the documents should be stored,
  - marking of the threaded rod with the envisaged embedment depth; this may be done by the manufacturer of the rod or the person on a job site,
- embedded reinforcing bars shall comply with specification given in Annex 7,
- checks before placing the anchor to ensure that the strength class of the concrete in which the anchor is to be placed is in the range given and is not lower than that of the concrete to which the characteristics loads apply,
- check of concrete being well compacted, e.g. without significant voids,
- marking and keeping the effective anchorage depth,
- keeping of the edge distance and spacing not less than the specified values without minus tolerances,
- positioning of the drill holes without damaging the reinforcement,
- in case of aborted drill hole: the drill hole shall be filled with mortar,
- cleaning the drill hole in accordance with Annexes 8 to 9, respectively,
- anchor installation ensuring the specified embedment depth, that is the appropriate depth marking of the anchor not exceeding the concrete surface or embedment depth control,
- threaded rods or fastening screw (including nut and washers) for the internal sleeves must be made of appropriate steel grade and property class,
- anchor component installation temperature shall be at least  $+5^{\circ}\text{C}$ ; during installation and curing of the injection mortar the temperature of the concrete must not fall below the temperature given in Annex 6; observing the curing time according to Annex 6, until the anchor may be loaded,
- torque moment given in Annex 4 must not be exceeded.



## **5 Indications to the manufacturer**

### **5.1 Manufacturer's responsibility**

It is the manufacturer's responsibility to ensure that the information on the specific conditions according to (1) and (2) including Annexes referred to in 4.2 and 4.3 is given to those who are concerned. This information may be made by reproduction of the respective parts of the European Technical Approval. In addition all installation data shall be shown clearly on the package and/or on an enclosed instruction sheet, preferably using illustration(s).

The minimum data required are:

- drill bit diameter,
- hole depth,
- diameter of anchor rod,
- minimum effective anchorage depth,
- information on the installation procedure, including cleaning of the hole with the cleaning equipment, preferably by means of the illustrations,
- admissible service temperature range,
- loading (curing) time of the bonding material depending on the installation temperature,
- reference to any special installation equipment needed,
- maximum torque moment,
- identification of the manufacturing batch.

All the data shall be presented in a clear and explicit form.

### **5.2 Recommendations on packaging, transport and storage**

The mortar cartridges and capsules shall be protected against sun radiation and shall be stored according to the manufacturer's instructions in dry conditions at temperatures of at least +5°C to not more than +25° C.

Mortar cartridges and capsules with expired shelf life must no longer be used.

The anchor shall only be packaged and supplied as a complete unit. The mortar cartridges and capsules may be packed separately from steel elements.

On behalf of Instytut Techniki Budowlanej

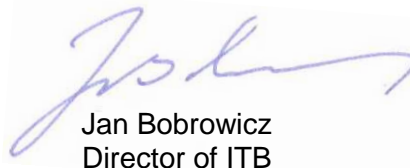

Jan Bobrowicz  
Director of ITB

**Internal sleeves: M6/10, M8/12, M10/16, M12/16, M16/24**

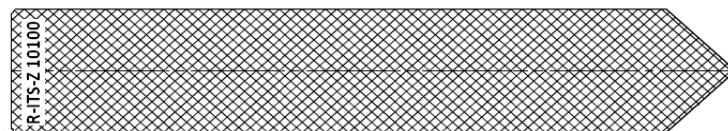
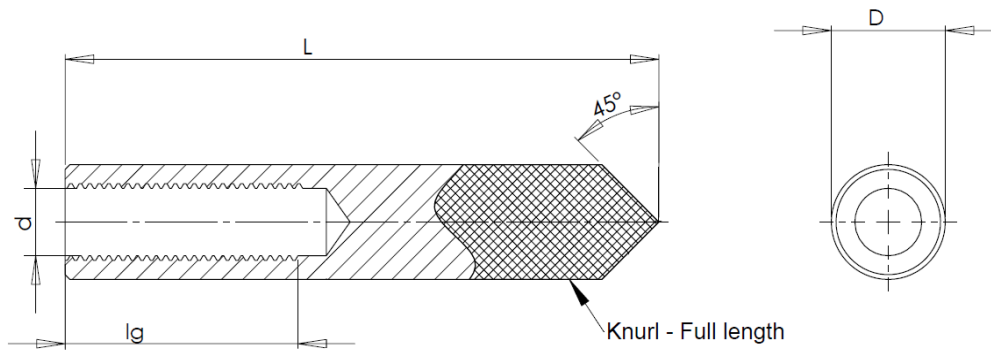

Marking: R - Identifying mark  
 ITS - product index  
 Z - carbon steel or A4 - stainless steel  
 XX - thread size  
 YYY - length of sleeve

**Reinforcing bars (rebars): Ø8 to Ø32**

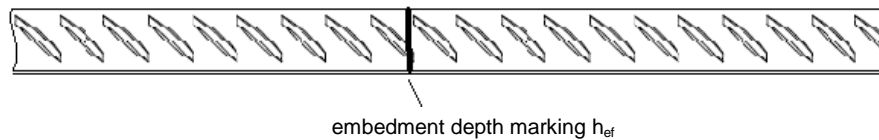

Use in non-cracked concrete only.

**Use category 1 and 2:** installation in dry or wet concrete or in a flooded holes (not sea water)

**Temperature range:** -40°C to +40°C (max. short term temp. +40°C and max. long term temp. +24°C)  
 -40°C to +80°C (max. short term temp. +80°C and max. long term temp. +50°C)

<p><b>R-KER / RV200, R-KER-W / RV200-W and R-KER-S / RV200-S</b></p>	<p><b>Annex 1</b></p>
<p>Product (steel elements) and intended use</p>	<p>of European                  Technical Approval                  ETA-13/0805</p>

**Coaxial cartridge –**

150 ml, 280 ml, 300 ml, 310 ml, 330 ml, 380 ml, 400 ml, 410 ml, 420 ml.

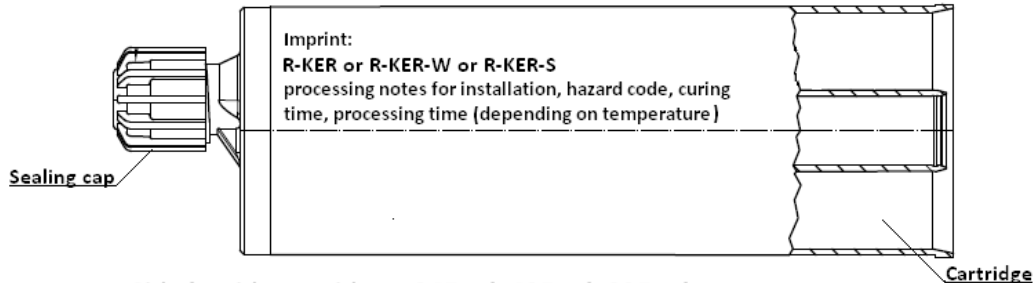

**Side by side cartridge – 345 ml, 425 ml, 825 ml.**

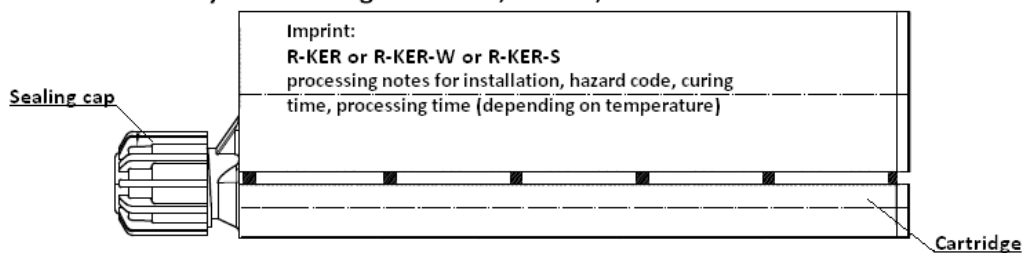

**Cartridge a single component for two part foil capsules –**

150 ml, 175 ml, 280ml, 300 ml, 310 ml, 380 ml, 400 ml, 550 ml, 600 ml.

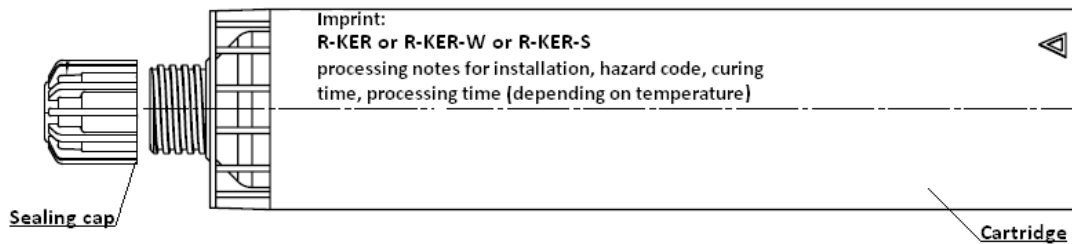

**Mixer for cartridge**

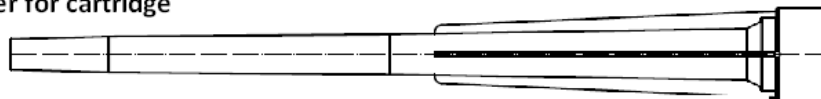

**R-KER / RV200, R-KER-W / RV200-W and R-KER-S / RV200-S**

Product (cartridge types and sizes)

**Annex 2**  
 of European  
 Technical Approval  
 ETA-13/0805

**Foil capsule (RAWL CFS system) –**

150 ml, 175 ml, 280ml, 300 ml, 310 ml, 380 ml, 400 ml, 550 ml, 600 ml.

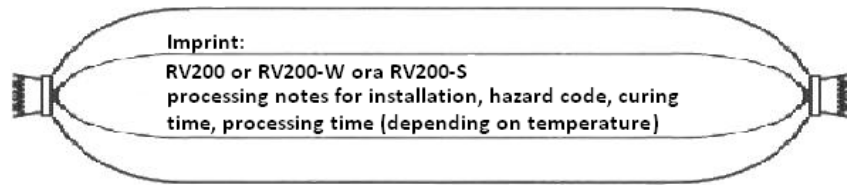

**Mixer for foil capsule (RAWL CFS system)**

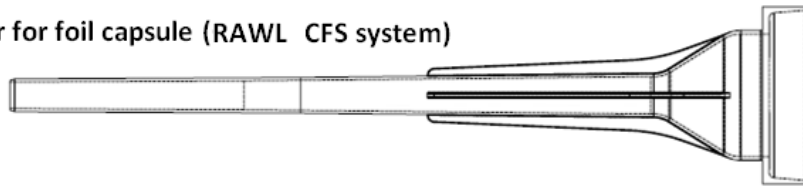

**Mixer standard plus adapter CFS+ for foil capsule**

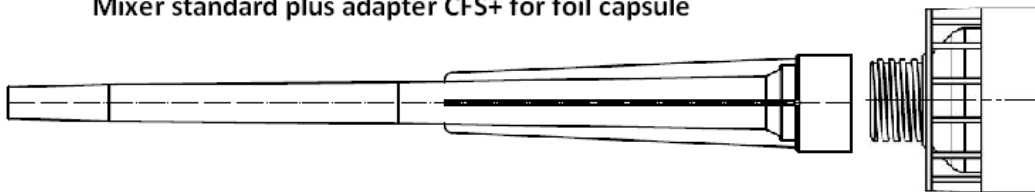

**Gun for foil capsule (RAWL CFS system)**

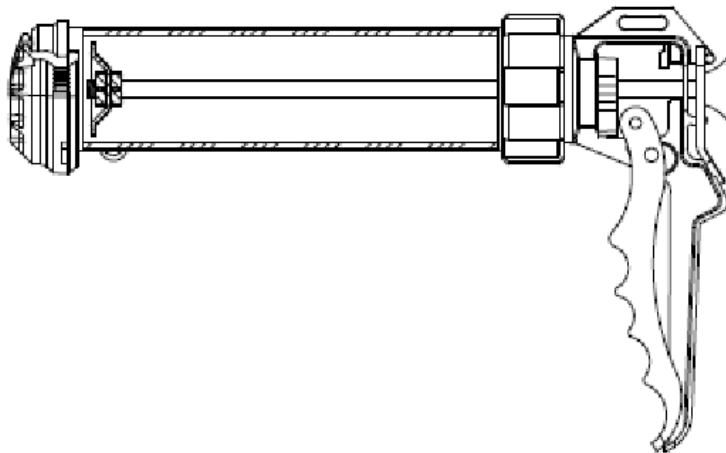

**R-KER / RV200, R-KER-W / RV200-W and R-KER-S / RV200-S**

Product (cartridge types and sizes)

**Annex 3**  
 of European  
 Technical Approval  
 ETA-13/0805

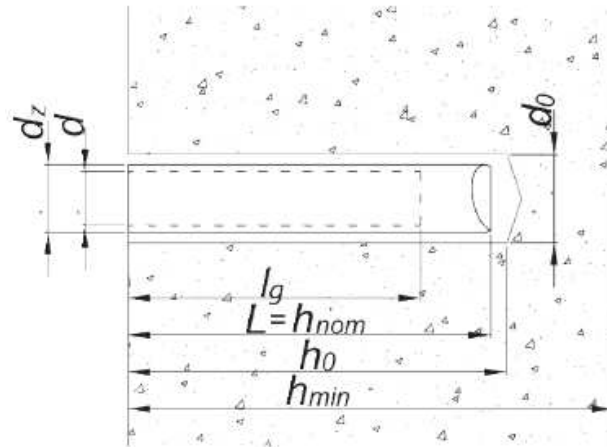

**Table 1: Installation parameters of internal sleeves**

Size			M6/10	M8/12	M8/12	M10/16	M10/16	M12/16	M16/24
Diameter of sleeve	d	[mm]	10	12	12	16	16	16	24
Drilling diameter	d <sub>0</sub>	[mm]	12	14	14	20	20	20	28
Diameter of the hole in the fixture	d <sub>f</sub>	[mm]	7	9	9	12	12	14	18
Depth of the drilling hole	h <sub>0</sub>	[mm]	h <sub>ef</sub> + 5 mm						
Embedment depth	h <sub>ef</sub>	[mm]	75	75	90	75	100	100	125
Minimum thickness of the concrete member	h <sub>min</sub>	[mm]	105	105	120	115	140	140	181
Max. torque moment	T <sub>inst</sub>	[Nm]	3	5	5	10	10	20	40
Thread engagement length, min-max	h <sub>s</sub>	[mm]	6-24	8-25	8-25	10-30	10-30	12-35	16-50
<b>Minimum spacing and edge distance</b>									
Minimum spacing	s <sub>min</sub>	[mm]	0,5 · h <sub>ef</sub> ≥ 40 mm						
Minimum edge distance	c <sub>min</sub>	[mm]	0,5 · h <sub>ef</sub> ≥ 40 mm						

<b>R-KER / RV200, R-KER-W / RV200-W and R-KER-S / RV200-S</b>	<b>Annex 4</b> of European Technical Approval ETA-13/0805
Installed anchor and installation parameters – internal sleeves	

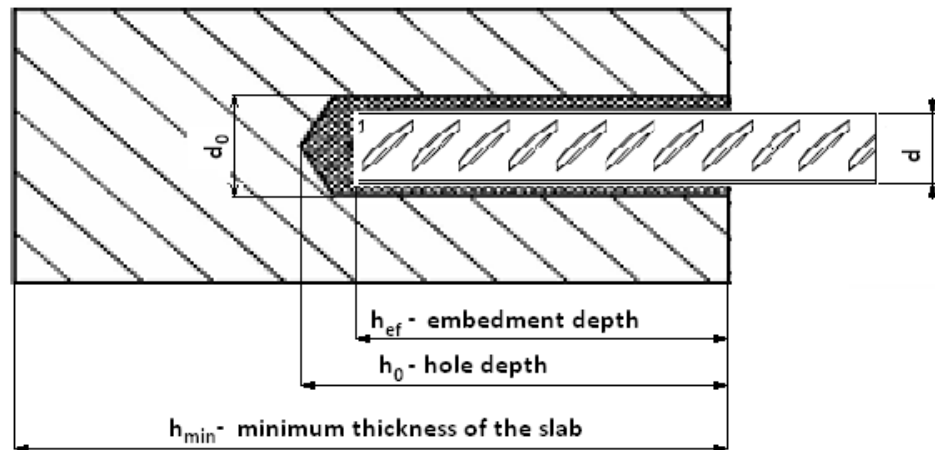

**Table 2: Installation parameters of rebars**

Size			Ø8	Ø10	Ø12	Ø14	Ø16	Ø20	Ø25	Ø32
Nominal diameter of rebar	d	[mm]	8	10	12	14	16	20	25	32
Drilling diameter	d <sub>0</sub>	[mm]	12	14	18	18	22	26	32	40
Depth of the drilling hole	h <sub>0</sub>	[mm]	h <sub>ef</sub> + 5							
Embedment depth	h <sub>ef, min</sub>	[mm]	60	70	80	80	100	120	140	165
	h <sub>ef, max</sub>	[mm]	100	120	145	145	190	240	290	360
Minimum thickness of the concrete member	h <sub>min</sub>	[mm]	h <sub>ef</sub> + 30 mm ≥ 100 mm		h <sub>ef</sub> + 2 · d <sub>0</sub>					
<b>Minimum spacing and edge distance</b>										
Minimum spacing	s <sub>min</sub>	[mm]	0,5 · h <sub>ef</sub> ≥ 40 mm							
Minimum edge distance	c <sub>min</sub>	[mm]	0,5 · h <sub>ef</sub> ≥ 40 mm							

**R-KER / RV200, R-KER-W / RV200-W and R-KER-S / RV200-S**

Installed anchor and installation parameters – reinforcing bars

**Annex 5**  
 of European  
 Technical Approval  
 ETA-13/0805

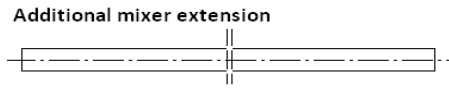

\*Variable length from 300mm up to 1000mm.

Manual blower pump

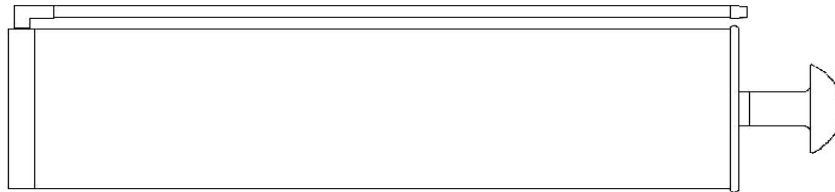

**Table 3a: Brush for internal sleeves**

Size	M6/10	M8/12	M10/16	M12/16	M16/24
Brush diameter [mm]	14	16	22	22	30

**Table 3b: Brush for rebars**

Size	Ø8	Ø10	Ø12	Ø14	Ø16	Ø20	Ø25	Ø32
Brush diameter [mm]	14	16	20	20	24	28	37	42

**Table 4: Processing time and curing time**

Mortar temperature	Base material temperature	Processing (open) time			Minimum curing time <sup>1)</sup>		
		RAWL R-KER /..	RAWL R-KER-W / ..	RAWL R-KER-S / ..	RAWL R-KER /..	RAWL R-KER-W / ..	RAWL R-KER-S / ..
5°C	-20°C	-	100 min.	-	-	24 h	-
5°C	-15°C	-	60 min.	-	-	16 h	-
5°C	-10°C	-	30 min.	-	-	8 h	-
5°C	-5°C	60 min.	16 min.	65 min.	6 h	4 h	24 h
5°C	0°C	40 min.	12 min.	-	3 h	2 h	-
5°C	5°C	20 min.	8 min.	35 min.	2 h	1 h	12 h
10°C	10°C	12 min.	5 min.	20 min.	80 min.	45 min.	8 h
15°C	15°C	8 min.	3 min.	12 min.	60 min.	30 min.	6 h
20°C	20°C	5 min.	2 min.	9 min.	45 min.	10 min.	4 h
25°C	25°C	-	-	7 min.	-	-	3 h
25°C	30°C	2 min.	-	6 min.	20 min.	-	2 h
25°C	40°C	0,5 min.	-	5 min.	10 min.	-	45 min.
25°C	45°C	-	-	3 min.	-	-	35 min.
25°C	50°C	-	-	3 min.	-	-	25 min.

<sup>1)</sup> curing time shall be doubled for the wet concrete

<b>R-KER / RV200, R-KER-W / RV200-W and R-KER-S / RV200-S</b>	<b>Annex 6</b> of European Technical Approval ETA-13/0805
Tools, processing time and curing time	

**Table 5: Materials – internal sleeves**

Designation	Materials
Internal sleeves made of zinc coated steel <sup>1)</sup>	Steel, property class 5.8 according to EN ISO 898-1; electroplated $\geq 5 \mu\text{m}$ according to EN ISO 4042 or hot-dip galvanized $\geq 45 \mu\text{m}$ according to EN ISO 10684
Internal sleeves made of stainless steel <sup>2)</sup>	Material 1.4401, 1.4404, 1.4571 according to EN 10088; property class 70 (A4-70) according to EN ISO 3506

<sup>1)</sup> related threaded rods or fastening screws: zinc coated steel strength class 5.8 or 8.8 acc. to EN ISO 898-1; electroplated  $\geq 5 \mu\text{m}$  acc. to EN ISO 4042 or hot-dip galvanized  $\geq 45 \mu\text{m}$  acc. to EN ISO 10684

<sup>2)</sup> related threaded rods or fastening screws: stainless steel 1.4401, 1.4404, 1.4571 acc. to EN 10088; property class 70 or 80 (A4-70 or A4-80) acc. to EN ISO 3506 or high corrosion resistance stainless steel 1.4529, 1.4565, 1.4547 acc. to EN 10088

**Table 6: Materials – rebars (according to EN 1992-1-1, Annex C, Tables C.1 and C.2N)**

Product form		Bars and de-coiled rods	
Class		B	C
Characteristic yield strength $f_{yk}$ or $f_{0,2k}$ [N/mm <sup>2</sup> ]		400 to 600	
Minimum value of $k = (f_t / f_y)_k$		$\geq 1,08$	$\geq 1,15$ < 1,35
Characteristic strain at maximum force, $\epsilon_{uk}$ [%]		$\geq 5,0$	$\geq 7,5$
Bendability		Bend / Rebind test	
Maximum deviation from nominal mass (individual bar), [%]	Nominal bar size [mm]	$\pm 6,0$ $\pm 4,5$	
	$\leq 8$ > 8		
Bond: minimum relative rib area, $f_{R,min}$	Nominal bar size [mm]	0,040 0,056	
	8 to 12 > 12		

**Rib height h:** The maximum rib height h shall be:  $h \leq 0,07 \cdot \emptyset$

**Table 7: Materials – injection mortar**





Product	Composition
R-KER / RV200, R-KER-W / RV200-W and R-KER-S / RV200-S	Bonding agent: vinylester resin styrene free Hardener: dibenzoyl peroxide Additive: quartz sand (filler)

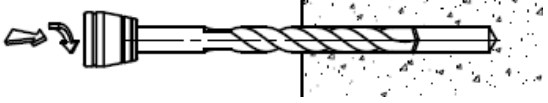
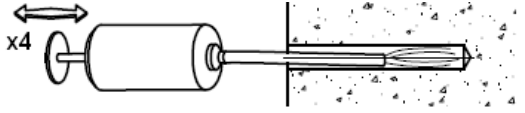
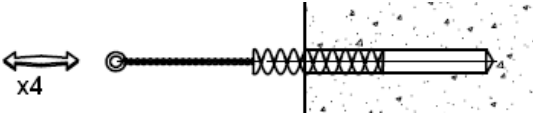
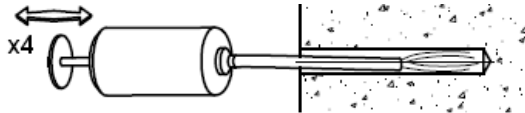

R-KER / RV200, R-KER-W / RV200-W and R-KER-S / RV200-S

Materials

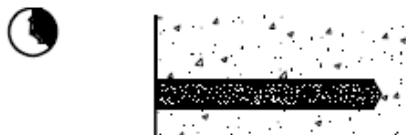
**Annex 7**  
of European  
Technical Approval  
ETA-13/0805

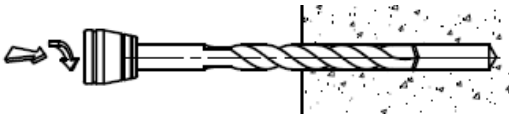
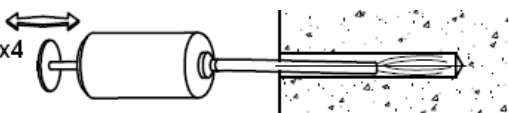
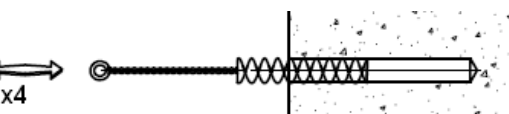
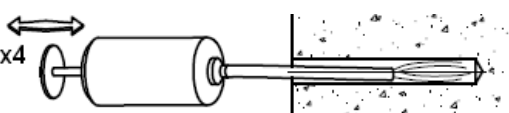
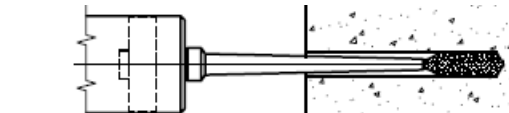

	<p>Drill a hole to the required diameter and depth using a rotary hammer drilling machine.</p>
	<p>Starting from the drill hole bottom blow the hole at least 4 times using the hand pump.</p>
	<p>Using the specified brush, mechanically brush out the hole at least 4 times.</p>
	<p>Starting from the drill hole bottom, blow at least 4 times with the hand pump.</p>
	<p>Insert the mixing nozzle to the far end of the hole and inject the mortar, slowly withdrawing the nozzle as the hole is filled to 2/3 of its' depth.</p>
	<p>Immediately insert the internal sleeve, slowly and with a slight twisting motion. Remove excess of mortar around the hole before it sets.</p>
	<p>Leave the fixing undisturbed until the cure time elapses.</p>
	<p>Attach the fixture and tighten the screw to the required torque.</p>
<p><b>R-KER / RV200, R-KER-W / RV200-W and R-KER-S / RV200-S</b></p>	
<p>Installation instruction – internal sleeves</p>	<p><b>Annex 8</b>                  of European                  Technical Approval                  ETA-13/0805</p>

	<p>Drill a hole to the required diameter and depth using a rotary hammer drilling machine.</p>				
	<p>Starting from the drill hole bottom blow the hole at least 4 times using the hand pump.</p>				
	<p>Using the specified brush, mechanically brush out the hole at least 4 times.</p>				
	<p>Starting from the drill hole bottom, blow at least 4 times with the hand pump.</p>				
	<p>Insert the mixing nozzle to the far end of the hole and inject the mortar, slowly withdrawing the nozzle as the hole is filled to 2/3 of its' depth.</p>				
	<p>Immediately insert the rebar, slowly and with a slight twisting motion. Remove excess of mortar around the hole before it sets.</p>				
	<p>Leave the fixing undisturbed until the curing time elapses.</p>				
<table border="1" style="width: 100%; border-collapse: collapse;"> <tbody> <tr> <td data-bbox="175 1736 1141 1870" style="text-align: center; vertical-align: middle;"> <p><b>R-KER / RV200, R-KER-W / RV200-W and R-KER-S / RV200-S</b></p> </td> <td data-bbox="1141 1736 1503 1995" style="text-align: center; vertical-align: middle;"> <p><b>Annex 9</b> of European Technical Approval ETA-13/0805</p> </td> </tr> <tr> <td data-bbox="175 1870 1141 1995" style="text-align: center; vertical-align: middle;"> <p>Installation instruction - rebars</p> </td> <td></td> </tr> </tbody> </table>		<p><b>R-KER / RV200, R-KER-W / RV200-W and R-KER-S / RV200-S</b></p>	<p><b>Annex 9</b> of European Technical Approval ETA-13/0805</p>	<p>Installation instruction - rebars</p>	
<p><b>R-KER / RV200, R-KER-W / RV200-W and R-KER-S / RV200-S</b></p>	<p><b>Annex 9</b> of European Technical Approval ETA-13/0805</p>				
<p>Installation instruction - rebars</p>					

**Table 8: Characteristic values of resistance to tension loads – internal sleeves**

Size	M6/ 10/75	M8/ 12/75	M8/ 12/90	M10/ 16/75	M10/ 16/100	M12/ 16/100	M16/ 24/125		
<b>Steel failure</b>									
Steel failure with standard threaded rod grade 5.8									
Characteristic resistance	$N_{Rk,s}$	[kN]	10	18	18	29	29	42	78
Partial safety factor	$\gamma_{Ms}^{1)}$	[-]	1,50						
Steel failure with standard threaded rod grade 8.8									
Characteristic resistance	$N_{Rk,s}$	[kN]	16	29	29	46	46	67	126
Partial safety factor	$\gamma_{Ms}^{1)}$	[-]	1,50						
Steel failure with standard stainless steel threaded rod A4-70									
Characteristic resistance	$N_{Rk,s}$	[kN]	14	26	26	41	41	59	110
Partial safety factor	$\gamma_{Ms}^{1)}$	[-]	1,87						
Steel failure with standard stainless steel threaded rod A4-80									
Characteristic resistance	$N_{Rk,s}$	[kN]	16	29	29	46	46	67	126
Partial safety factor	$\gamma_{Ms}^{1)}$	[-]	1,60						
Steel failure with standard high corrosion threaded rod grade 70									
Characteristic resistance	$N_{Rk,s}$	[kN]	14	26	26	41	41	59	110
Partial safety factor	$\gamma_{Ms}^{1)}$	[-]	1,87						
<b>Combined pull-out and concrete cone failure</b>									
Characteristic resistance in non-cracked concrete C20/25									
Temperature range I: 40°C/24°C	$\tau_{Rk,ucr}$	[N/mm <sup>2</sup> ]	7,5	9,0	9,0	9,5	9,5	8,5	7,0
Temperature range II: 80°C/50°C	$\tau_{Rk,ucr}$	[N/mm <sup>2</sup> ]	6,0	7,0	7,0	7,5	7,5	6,5	5,5
Increasing factor for $\tau_{Rk,ucr}$ in non-cracked concrete	$\psi_c$	C30/37	1,04					1,00	
		C40/50	1,07					1,00	
		C50/60	1,09					1,00	
Partial safety factors for use category 1	$\gamma_{Mc} = \gamma_{Mp}$	[-]	1,8						
Partial safety factors for use category 2	$\gamma_{Mc} = \gamma_{Mp}$	[-]	1,8					2,1	
<b>Splitting failure</b>									
Effective anchorage depth	$h_{ef}$	[mm]	75	75	90	75	100	100	125
Edge distance	$c_{cr,sp}$ for $h_{min}$	[mm]	$2,0 \cdot h_{ef}$					$1,5 \cdot h_{ef}$	
	$c_{cr,sp}$ for $h_{min} < h^2) < 2 \cdot h_{ef}$ ( $c_{cr,sp}$ from linear interpolation)	[mm]							
	$c_{cr,sp}$ for $h \geq 2 \cdot h_{ef}$	[mm]	$c_{Cr,Np}$						
Spacing	$s_{cr,sp}$	[mm]	$2,0 \cdot c_{cr,sp}$						

<sup>1)</sup> in the absence of national regulations

<sup>2)</sup> h – concrete member thickness;  $h_{ef}$  – anchorage depth

**R-KER / RV200, R-KER-W / RV200-W and R-KER-S / RV200-S**

Characteristic resistance under tension loads – design method A.  
 Internal sleeves

**Annex 10**  
 of European  
 Technical Approval  
 ETA-13/0805

**Table 9: Shear loads for steel failure without lever arm – internal sleeves**

Size			M6/ 10/75	M8/ 12/75	M8/ 12/90	M10/ 16/75	M10/ 16/100	M12/ 16/100	M16/ 24/125
<b>Steel failure with standard threaded rod grade 5.8</b>									
Characteristic resistance	$V_{Rk,s}$	[kN]	5	9	9	14	14	21	39
Partial safety factor	$\gamma_{Ms}$	[-]	1,25						
<b>Steel failure with standard threaded rod grade 8.8</b>									
Characteristic resistance	$V_{Rk,s}$	[kN]	8	15	15	23	23	34	63
Partial safety factor	$\gamma_{Ms}$	[-]	1,25						
<b>Steel failure with standard stainless steel threaded rod A4-70</b>									
Characteristic resistance	$V_{Rk,s}$	[kN]	7	13	13	20	20	29	55
Partial safety factor	$\gamma_{Ms}$	[-]	1,56						
<b>Steel failure with standard stainless steel threaded rod A4-80</b>									
Characteristic resistance	$V_{Rk,s}$	[kN]	8	15	15	23	23	34	63
Partial safety factor	$\gamma_{Ms}$	[-]	1,33						
<b>Steel failure with high corrosion stainless steel threaded rod grade 70</b>									
Characteristic resistance	$V_{Rk,s}$	[kN]	7	13	13	20	20	29	55
Partial safety factor	$\gamma_{Ms}$	[-]	1,56						

**Table 10: Shear loads for steel failure with lever arm – internal sleeves**

Size			M6/ 10/75	M8/ 12/75	M8/ 12/90	M10/ 16/75	M10/ 16/100	M12/ 16/100	M16/ 24/125
<b>Steel failure with standard threaded rod grade 5.8</b>									
Characteristic resistance	$M^0_{Rk,s}$	[Nm]	8	19	19	37	37	65	166
Partial safety factor	$\gamma_{Ms}$	[-]	1,25						
<b>Steel failure with standard threaded rod grade 8.8</b>									
Characteristic resistance	$M^0_{Rk,s}$	[Nm]	12	30	30	60	60	105	266
Partial safety factor	$\gamma_{Ms}$	[-]	1,25						
<b>Steel failure with standard stainless steel threaded rod A4-70</b>									
Characteristic resistance	$M^0_{Rk,s}$	[Nm]	11	26	26	52	52	92	233
Partial safety factor	$\gamma_{Ms}$	[-]	1,56						
<b>Steel failure with standard stainless steel threaded rod A4-80</b>									
Characteristic resistance	$M^0_{Rk,s}$	[Nm]	12	30	30	60	60	105	266
Partial safety factor	$\gamma_{Ms}$	[-]	1,33						
<b>Steel failure with high corrosion stainless steel threaded rod grade 70</b>									
Characteristic resistance	$M^0_{Rk,s}$	[Nm]	11	26	26	52	52	92	233
Partial safety factor	$\gamma_{Ms}$	[-]	1,56						

**R-KER / RV200, R-KER-W / RV200-W and R-KER-S / RV200-S**

Characteristic resistance under shear loads – design method A.  
 Internal sleeves

**Annex 11**  
 of European  
 Technical Approval  
 ETA-13/0805

**Table 11: Concrete pry out failure and concrete edge failure – internal sleeves**

Size			M6/ 10/75	M8/ 12/75	M8/ 12/90	M10/ 16/75	M10/ 16/100	M12/ 16/100	M16/ 24/125
Effective anchorage depth	$h_{ef}$	[mm]	75	75	90	75	100	100	125
<b>Pry out failure</b>									
Factor	k	[-]	2	2	2	2	2	2	2
Partial safety factor	$\gamma_{Mp}$	[-]	1,5						
<b>Concrete edge failure: see clause 5.2.3.4 of Technical Report TR 029</b>									
Partial safety factor	$\gamma_{Mc}$	[-]	1,5						

**Table 12: Displacement under tension loads – internal sleeves**

Size			M6/10/75	M8/12/75	M8/12/90	M10/16/75	M10/16/100	M12/16/100	M16/24/125
<b>Characteristic displacement in non-cracked C20/25 to C50/60 concrete under tension loads</b>									
Admissible service load <sup>1)</sup>	F	[kN]	7,1	10,3	10,3	14,6	14,6	17,4	23,2
Displacement	$\delta_{N0}$	[mm]	0,21	0,22	0,22	0,24	0,24	0,30	0,34
	$\delta_{N\infty}$	[mm]	0,60	0,60	0,60	0,60	0,60	0,60	0,60

<sup>1)</sup>  $F = F_{Rk} / \gamma_F \cdot \gamma_{Mc}$ , with  $\gamma_F = 1,4$

**Table 13: Displacement under shear loads – internal sleeves**

Size			M6/10/75	M8/12/75	M8/12/90	M10/16/75	M10/16/100	M12/16/100	M16/24/125
<b>Characteristic displacement under shear loads</b>									
Admissible service load <sup>1)</sup>	F	[kN]	6,4	11,6	11,6	18,4	18,4	26,7	49,8
Displacement	$\delta_{V0}$	[mm]	2,5	2,5	2,5	2,5	2,5	2,5	2,5
	$\delta_{V\infty}$	[mm]	3,7	3,7	3,7	3,7	3,7	3,7	3,7

<sup>1)</sup>  $F = F_{Rk} / \gamma_F \cdot \gamma_{Mc}$ , with  $\gamma_F = 1,4$

**R-KER / RV200, R-KER-W / RV200-W and R-KER-S / RV200-S**

Characteristic resistance under shear loads – design method A.  
 Displacement under service loads: tension and shear. Internal sleeves

**Annex 12**  
 of European  
 Technical Approval  
 ETA-13/0805

**Table 14: Characteristic values of resistance to tension loads – reinforcing bars**

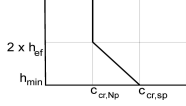
Size			Ø8	Ø10	Ø12	Ø14	Ø16	Ø20	Ø25	Ø32	
<b>Steel failure</b>											
Steel failure with reinforcing bar B500B											
Characteristic resistance	$N_{Rk,s}$	[kN]	27,6	43,2	62,2	84,7	110,6	172,8	270,0	442,3	
Partial safety factor	$\gamma_{Ms}$ <sup>1)</sup>	[-]	1,4								
<b>Combined pull-out and concrete cone failure</b>											
Characteristic resistance in non-cracked concrete C20/25											
Temperature range I: 40°C/24°C	$\tau_{Rk,ucr}$	[N/mm <sup>2</sup> ]	11	10	10	9	9	7,5	7	6,5	
Temperature range II: 80°C/50°C	$\tau_{Rk,ucr}$	[N/mm <sup>2</sup> ]	9	8	8	7	7	6	6	5	
Increasing factor C30/37	$\psi_c$	[-]	1,04					1,00			
Increasing factor C40/50			1,07								
Increasing factor C50/60			1,09								
Partial safety factors for use category 1 and 2	$\gamma_{Mc} = \gamma_{Mp}$	[-]	1,8	1,8	1,8	1,8	1,8	1,8	1,8	1,8	
<b>Splitting failure</b>											
Effective anchorage depth $h_{ef}$	min	[mm]	60	70	80	80	100	120	140	165	
	max	[mm]	100	120	145	145	190	240	290	360	
Edge distance	$c_{cr,sp}$ for $h_{min}$	[mm]	$2,5 \cdot h_{ef}$			$2,0 \cdot h_{ef}$		$1,5 \cdot h_{ef}$			
	$c_{cr,sp}$ for $h_{min} < h^2) < 2 \cdot h_{ef}$ ( $c_{cr,sp}$ from linear interpolation)	[mm]									
	$c_{cr,sp}$ for $h \geq 2 \cdot h_{ef}$	[mm]	$c_{cr,Np}$								
Spacing	$s_{cr,sp}$	[mm]	$2,0 \cdot c_{cr,sp}$								

<sup>1)</sup> in the absence of national regulations  
<sup>2)</sup> h – concrete member thickness

**R-KER / RV200, R-KER-W / RV200-W and R-KER-S / RV200-S**

Characteristic resistance under tension loads – design method A.  
 Reinforcing bars

**Annex 13**  
 of European  
 Technical Approval  
 ETA-13/0805

**Table 15: Characteristic values of resistance to shear loads for steel failure without lever arm – reinforcing bars**

Size			Ø8	Ø10	Ø12	Ø14	Ø16	Ø20	Ø25	Ø32
<b>Steel failure with reinforcing bars (rebars acc. to Annex 7, Table 6; <math>f_{uk} \geq 550</math> MPa) <sup>1)</sup></b>										
Characteristic resistance	$V_{Rk,s}$	[kN]	13,8	21,6	31,1	42,3	55,3	86,4	135,0	221,2
Partial safety factor	$\gamma_{Ms}$	[-]	1,5							

<sup>1)</sup> The characteristic resistance  $V_{Rk,s}$  shall be determined acc. to Technical Report TR 029, equation (5.5)

**Table 16: Characteristic values of resistance to shear loads for steel failure with lever arm – reinforcing bars**

Size			Ø8	Ø10	Ø12	Ø14	Ø16	Ø20	Ø25	Ø32
<b>Steel failure with reinforcing bars (rebars acc. to Annex 7, Table 6; <math>f_{uk} \geq 550</math> MPa) <sup>1)</sup></b>										
Characteristic resistance	$M^0_{Rk,s}$	[Nm]	33	65	112	178	265	518	1012	2123
Partial safety factor	$\gamma_{Ms}$	[-]	1,5							

<sup>1)</sup> The characteristic resistance  $M^0_{Rk,s}$  shall be determined acc. to Technical Report TR 029, equation (5.6b)

**R-KER / RV200, R-KER-W / RV200-W and R-KER-S / RV200-S**

Characteristic resistance under shear loads – design method A.  
 Reinforcing bars

**Annex 14**  
 of European  
 Technical Approval  
 ETA-13/0805

**Table 17: Concrete pry out failure and concrete edge failure – reinforcing bars**

Size			Ø8	Ø10	Ø12	Ø14	Ø16	Ø20	Ø25	Ø32
<b>Pry out failure</b>										
Factor	k	[-]	2	2	2	2	2	2	2	2
Partial safety factor	$\gamma_{Mp}$	[-]	1,5							
<b>Concrete edge failure: see clause 5.2.3.4 of Technical Report TR 029</b>										
Partial safety factor	$\gamma_{Mc}$	[-]	1,5							

**Table 18: Displacement under tension loads – reinforcing bars**

Size			Ø8	Ø10	Ø12	Ø14	Ø16	Ø20	Ø25	Ø32
<b>Characteristic displacement in non-cracked concrete C20/25 to C50/60 under tension loads</b>										
Admissible service load <sup>1)</sup>	F	[kN]	6,9	9,1	13,4	12,8	19,2	24,4	33,5	44,6
Displacement	$\delta_{N0}$	[mm]	0,20	0,30	0,35	0,35	0,35	0,41	0,45	0,47
	$\delta_{N\infty}$	[mm]	0,60	0,60	0,60	0,60	0,60	0,60	0,60	0,60

<sup>1)</sup>  $F = F_{Rk} / \gamma_F \cdot \gamma_{Mc}$ , with  $\gamma_F = 1,4$

**Table 19: Displacement under shear loads – reinforcing bars**

Size			Ø8	Ø10	Ø12	Ø14	Ø16	Ø20	Ø25	Ø32
<b>Characteristic displacement in non-cracked concrete C20/25 to C50/60 under shear loads</b>										
Admissible service load <sup>1)</sup>	F	[kN]	3,7	5,8	8,4	8,4	15,7	24,5	35,3	55,6
Displacement	$\delta_{V0}$	[mm]	2,5	2,5	2,5	2,5	2,5	2,5	2,5	2,5
	$\delta_{V\infty}$	[mm]	3,7	3,7	3,7	3,7	3,7	3,7	3,7	3,7

<sup>1)</sup>  $F = F_{Rk} / \gamma_F \cdot \gamma_{Mc}$ , with  $\gamma_F = 1,4$

**R-KER / RV200, R-KER-W / RV200-W and R-KER-S / RV200-S**

Characteristic resistance under shear loads – design method A.  
 Displacement under service loads: tension and shear. Reinforcing bars

**Annex 15**  
 of European  
 Technical Approval  
 ETA-13/0805