

Deutsches Institut für Bautechnik

Anstalt des öffentlichen Rechts

Kolonnenstr. 30 B
10829 Berlin
Germany

Tel.: +49(0)30 787 30 0
Fax: +49(0)30 787 30 320
E-mail: dibt@dibt.de
Internet: www.dibt.de

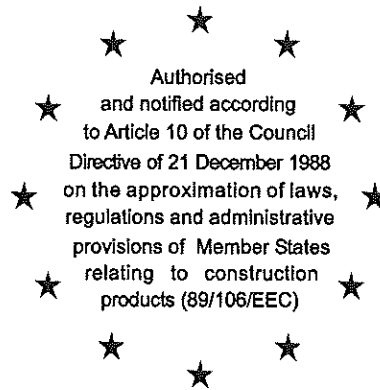

DIBt

Mitglied der EOTA
Member of EOTA

European Technical Approval ETA-10/0183

English translation prepared by DIBt - Original version in German language

Handelsbezeichnung
Trade name

OCWS 4,8 x L, OCWS 5,5 x L, OCS 5,5 x L, ONS 5,5 x L,
ODWS 6,5 x L

Zulassungsinhaber
Holder of approval

KOELNER S.A.
Kwidzynska 6
51-416 Wroclaw
POLEN

**Zulassungsgegenstand
und Verwendungszweck**
*Generic type and use
of construction product*

Befestigungsschrauben für Bauteile und Bleche aus Metall
Fastening screws for metal members and sheeting

Geltungsdauer: vom
Validity: from
bis
to

17 August 2010
17 August 2015

Herstellwerk
Manufacturing plant

KOELNER S.A.
Kwidzynska 6
51-416 Wroclaw
POLEN

Diese Zulassung umfasst
This Approval contains

17 Seiten einschließlich 9 Anhänge
17 pages including 9 annexes



Europäische Organisation für Technische Zulassungen
European Organisation for Technical Approvals

I LEGAL BASES AND GENERAL CONDITIONS

- 1 This European technical approval is issued by Deutsches Institut für Bautechnik in accordance with:
 - Council Directive 89/106/EEC of 21 December 1988 on the approximation of laws, regulations and administrative provisions of Member States relating to construction products¹, modified by Council Directive 93/68/EEC² and Regulation (EC) N° 1882/2003 of the European Parliament and of the Council³;
 - Gesetz über das In-Verkehr-Bringen von und den freien Warenverkehr mit Bauprodukten zur Umsetzung der Richtlinie 89/106/EWG des Rates vom 21. Dezember 1988 zur Angleichung der Rechts- und Verwaltungsvorschriften der Mitgliedstaaten über Bauprodukte und anderer Rechtsakte der Europäischen Gemeinschaften (Bauproduktengesetz - BauPG) vom 28. April 1998⁴, as amended by law of 31 October 2006⁵;
 - Common Procedural Rules for Requesting, Preparing and the Granting of European technical approvals set out in the Annex to Commission Decision 94/23/EC⁶.
- 2 Deutsches Institut für Bautechnik is authorized to check whether the provisions of this European technical approval are met. Checking may take place in the manufacturing plant. Nevertheless, the responsibility for the conformity of the products to the European technical approval and for their fitness for the intended use remains with the holder of the European technical approval.
- 3 This European technical approval is not to be transferred to manufacturers or agents of manufacturers other than those indicated on page 1, or manufacturing plants other than those indicated on page 1 of this European technical approval.
- 4 This European technical approval may be withdrawn by Deutsches Institut für Bautechnik, in particular pursuant to information by the Commission according to Article 5(1) of Council Directive 89/106/EEC.
- 5 Reproduction of this European technical approval including transmission by electronic means shall be in full. However, partial reproduction can be made with the written consent of Deutsches Institut für Bautechnik. In this case partial reproduction has to be designated as such. Texts and drawings of advertising brochures shall not contradict or misuse the European technical approval.
- 6 The European technical approval is issued by the approval body in its official language. This version corresponds fully to the version circulated within EOTA. Translations into other languages have to be designated as such.

1 Official Journal of the European Communities L 40, 11 February 1989, p. 12
2 Official Journal of the European Communities L 220, 30 August 1993, p. 1
3 Official Journal of the European Union L 284, 31 October 2003, p. 25
4 *Bundesgesetzblatt Teil I 1998*, p. 812
5 *Bundesgesetzblatt Teil I 2006*, p. 2407, 2416
6 Official Journal of the European Communities L 17, 20 January 1994, p. 34

II SPECIFIC CONDITIONS OF THE EUROPEAN TECHNICAL APPROVAL

1 Definition of the product and intended use

1.1 Definition of the construction product

The fastening screws OCWS, OCS, ONS and ODWS are self drilling screws listed in Table 1. The self drilling screws are made of stainless steel. They are partly completed with metallic washers and EPDM sealing rings. For details see the appropriate Annexes.

Examples of fastening screws and the corresponding connections are shown in Annex 1.

The self drilling screws and the corresponding connections are subject to tension and shear forces.

Table 1 Different types of self drilling screws

No.	Self drilling screw	Description	Annex
1	OCWS-4,8	with hexagon head and sealing washer $\geq \text{Ø}14$ mm	Annex 2
2	OCWS-5,5	with hexagon head and sealing washer $\geq \text{Ø}16$ mm	Annex 3
3	OCWS-5,5	with hexagon head and sealing washer $\geq \text{Ø}16$ mm	Annex 4
4 ⁾	ODWS-6,5	with hexagon head and sealing washer $\geq \text{Ø}16$ mm	Annex 5
5 ⁾	OCS-5,5	with hexagon head and sealing washer $\geq \text{Ø}16$ mm	Annex 6
6	OCS-5,5	with hexagon head and sealing washer $\geq \text{Ø}16$ mm	Annex 7
7	ONS-5,5	with hexagon head and sealing washer $\geq \text{Ø}16$ mm	Annex 8
8	ONS-5,5	with hexagon head	Annex 9

^{*)} These self drilling screws are applicable for fastening to timber substructure

1.2 Intended use

The self drilling screws are intended to be used for fastening steel sheeting to steel substructures and as far as stated in Table 1 to timber substructures. The sheeting can either be used as wall or roof cladding or as load bearing wall and roof element.

The self drilling screws can also be used for the fastening of other thin gauge steel members.

The component to be fastened is component I and the substructure is component II.

The intended use comprises self drilling screws and connections for indoor and outdoor applications. The self drilling screws made of stainless steel are intended to be used in external environments with a high or very high corrosion category.

The intended use comprises connections with predominantly static loads (e.g. wind loads, dead loads).

The provisions made in this European technical approval are based on an assumed working life of the self drilling screws of 25 years. The indications given on the working life cannot be interpreted as a guarantee given by the producer, but are to be regarded only as a means for choosing the right products in relation to the expected economically reasonable working life of the works.

2 Characteristics of product and methods of verification

2.1 Characteristics of product

The self drilling screws shall correspond to the drawings given in the appropriate Annexes (see Table 1).

The characteristic material values, dimensions and tolerances of the self drilling screws neither indicated in this section nor in the Annexes shall correspond to the respective values laid down in the technical documentation⁷ to this European technical approval.

The characteristic values of the shear and tension resistance of the connections made with the self drilling screws are given in the appropriate Annexes or in section 4.2.

The self drilling screws are considered to satisfy the requirements of performance class A1 of the characteristic reaction to fire.

2.2 Methods of verification

The assessment of the fitness of the self drilling screws for the intended use in relation to the Essential Requirements ER 1 (Mechanical resistance and stability), ER 2 (Safety in case of fire), ER 4 (Safety in use) and additional aspects of durability has been made in accordance with section 3.2 of the Common Procedural Rules for Requesting, Preparing and the Granting of European technical approvals set out in the Annex to Commission Decision 94/23/EC⁶.

The assessment of the resistance to fire performance is only relevant to the assembled system (self drilling screws, sheeting, substructure) which is not part of the ETA.

The self drilling screws are considered to satisfy the requirements of performance class A 1 of the characteristic reaction to fire, in accordance with the provisions of the EC Decision 96/603/EC (as amended) without the need for testing on the basis of its listing in that decision.

Concerning Essential Requirements No. 1 (Mechanical resistance and stability) and No. 4 (Safety in use) the following applies:

The characteristic values of resistance given in the Annexes were determined by shear and tension tests.

The formulas to calculate the design resistance are given in clause 4.2.1.

⁷ The technical documentation to this European technical approval is deposited at Deutsches Institut für Bautechnik and, as far as relevant for the tasks of the approved bodies involved in the attestation of conformity procedure is handed over to the approved bodies.

3 Evaluation and attestation of conformity and CE marking

3.1 System of attestation of conformity

According to the Decision 99/92 of the European Commission⁸ system 3 of the attestation of conformity applies.

This system of attestation of conformity is defined as follows:

System 3: Declaration of conformity of the product by the manufacturer on the basis of:

- (a) Tasks for the manufacturer:
 - (1) factory production control;
- (b) Tasks for the approved body:
 - (2) initial type-testing of the product.

Note: Approved bodies are also referred to as "notified bodies".

3.2 Responsibilities

3.2.1 Tasks for the manufacturer

3.2.1.1 Factory production control

The manufacturer shall exercise permanent internal control of production. All the elements, requirements and provisions adopted by the manufacturer shall be documented in a systematic manner in the form of written policies and procedures, including records of results performed. This production control system shall insure that the product is in conformity with this European technical approval.

The manufacturer may only use initial materials stated in the technical documentation of this European technical approval.

The factory production control shall be in accordance with the "control plan of September 2010 relating to the European technical approval ETA-10/0183 issued on 17 August 2010" which is part of the technical documentation of this European technical approval. The control plan is laid down in the context of the factory production control system operated by the manufacturer and deposited with Deutsches Institut für Bautechnik.⁹

The results of factory production control shall be recorded and evaluated in accordance with the provisions of the control plan.

3.2.1.2 Other tasks for the manufacturer

The manufacturer shall, on the basis of a contract, involve a body which is approved for the tasks referred to in section 3.1 in the field of self drilling screws in order to undertake the actions laid down in section 3.2.2. For this purpose, the control plan referred to in sections 3.2.1.1 and 3.2.2 shall be handed over by the manufacturer to the approved body involved.

The manufacturer shall make a declaration of conformity, stating that the construction product is in conformity with the provisions of the European technical approval ETA-10/0183 issued on 17 August 2010.

3.2.2 Tasks for the approved bodies

The approved body shall perform the

- initial type-testing of the product,

in accordance with the provisions laid down in the control plan.

The approved body shall retain the essential points of its actions referred to above and state the results obtained and conclusions drawn in written reports.

⁸ Official Journal of the European Communities L 80 of 18.03.1998.

⁹ The "control plan" is a confidential part of the European technical approval and only handed over to the approved body involved in the procedure of attestation of conformity. See section 3.2.2.

3.3 CE marking

The CE marking shall be affixed on each packaging of self drilling screws. The letters "CE" shall be followed by the identification number of the approved certification body, where relevant, and be accompanied by the following additional information:

- the name and address of the producer (legal entity responsible for the manufacture),
- the last two digits of the year in which the CE marking was affixed,
- the number of the European technical approval,
- the name of the product.

4 Assumptions under which the fitness of the product for the intended use was favourably assessed

4.1 Manufacturing

The self drilling screws are manufactured in accordance with the provisions of the European technical approval using the manufacturing process as laid down in the technical documentation.

The European technical approval is issued for the product on the basis of agreed data/information, deposited with Deutsches Institut für Bautechnik, which identifies the product that has been assessed and judged. Changes to the product or production process, which could result in this deposited data/information being incorrect, should be notified to Deutsches Institut für Bautechnik before the changes are introduced. Deutsches Institut für Bautechnik will decide whether or not such changes affect the approval and consequently the validity of the CE marking on the basis of the approval and if so whether further assessment or alterations to the approval shall be necessary.

4.2 Design

4.2.1 General

Self drilling screws completely or partly exposed to external weather or similar conditions are made of stainless steel. For the corrosion protection the rules given in EN 1993-1-4:2006 are taken into account.

For the types of connection (a, b, c, d) listed in the Annexes it is not necessary to take into account the effect of constraints due to temperature. For other types of connection it shall be considered for design as long as constraining forces due to temperature do not occur or are not significant (e. g. sufficient flexibility of the structure).

The loading is predominantly static. (Remark: Wind loads are regarded as predominantly static.)

Dimensions, material properties, torque moments $M_{t,nom}$, minimum effective screw-in length l_{ef} and nominal material thicknesses t_N as stated in the ETA or in the Annexes are observed.

The verification concept stated in EN 1990:2002 is used for the design of the connections made with the self drilling screws. The characteristic values (shear and tension resistance) stated in the Annexes are used for the design of the entire connections.

The following formulas are used to calculate the values of design resistance:

$$N_{Rd} = \frac{N_{Rk}}{\gamma_M}$$

$$V_{Rd} = \frac{V_{Rk}}{\gamma_M}$$

The recommended partial safety factor $\gamma_M = 1.33$ is used in order to determine the corresponding design resistances, provided no values are given in national regulations of the member state in which the self drilling screws are used or in the respective National Annex to Eurocode 3.

In case of combined tension and shear forces the linear interaction formula according to EN 1993-1-3:2006, section 8.3 (8) is taken into account.

$$\frac{N_{Sd}}{N_{Rd}} + \frac{V_{Sd}}{V_{Rd}} \leq 1.0$$

The possibly required reduction of the tension resistance due to the position of the self drilling screw is taken into account in accordance with EN 1993-1-3:2006, section 8.3 (7) and Fig. 8.2.

4.2.2 Additional rules for connections with timber substructures

As far as no other provisions are made in the following EN 1995-1-1:2004 + A1:2008 applies.

Drill points of self drilling screws are not taken into account for the effective screw-in length.

The following terms are used:

l_g - Screw-in length - part of thread screwed into component II including drill point.

l_b - Length of unthreaded part of the drill-point.

l_{ef} - effective screw-in length $l_{ef} = l_g - l_b$

$N_{R,k} = F_{ax,Rk} \cdot k_{mod}$

$V_{R,k} = F_{v,Rk} \cdot k_{mod}$

$F_{ax,Rk}$ according to EN 1995-1-1:2004 + A1:2008, equation (8.40a)

Remark: $F_{ax,Rk} = F_{ax,\alpha,Rk}$ with $\alpha = 90^\circ$

$F_{v,Rk}$ according to EN 1995-1-1:2004 + A1:2008, clause 8.2.3

k_{mod} according to EN 1995-1-1:2004 + A1:2008, Table 3.1

$M_{y,Rk}$ in equation (8.9) of EN 1995-1-1:2004 + A1:2008 and $f_{ax,k}$ in equation (8.40a) of EN 1995-1-1:2004 + A1:2008 are given in the Annexes of this ETA.

The characteristic values for pullout and bearing resistance (timber substructure) calculated according to EN 1995-1-1:2004 + A1:2008 are compared with the characteristic values for component I (pull over and bearing resistance) stated in the right column of the table in the appropriate Annexes. The lower value is used for further calculations.

4.3 Installation

The installation is only carried out according to the manufacturer's instructions. The manufacturer hands over the assembly instructions to the assembler.

It is guaranteed by the execution that no bimetallic corrosion will occur.

For regular shear forces the components I and II are directly connected to each other so that the self drilling screws do not get additional bending. The use of compression resistant thermal insulation strips up to a thickness of 3 mm is allowed.

The self drilling screws are fixed rectangular to the surface of the components to guarantee a correct load bearing and if necessary rain-proof connection.

Self drilling screws for steel substructures are screwed in with the cylindrical part of the thread at least 6 mm if the substructure has a thickness over 6 mm unless otherwise declared in the manufacturer's instruction. Welded drill points are not taken into account for the screw-in length.

The conformity of the installed fasteners with the provisions of the ETA is attested by the executing company.

5 Indications to the manufacturer

It is in the responsibility of the manufacturer to ensure that the information on the specific conditions according to 1, 2, 4.2 and 4.3 (including Annexes referred to) is given to those who are concerned. This information may be given by reproduction of the respective parts of the European technical approval.

In addition all installation data (predrill diameter, torque moment, application limits) shall be shown clearly on the package and/or on an enclosed instruction sheet, preferably using illustration(s).

Georg Feistel
Head of Department

beglaubigt:
Ulbrich

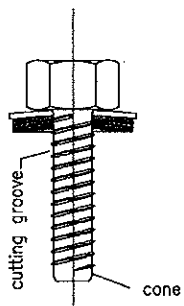

self tapping screw
with sealing washer

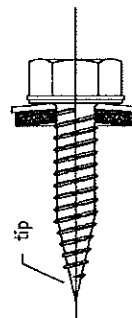

self tapping screw
with sealing washer

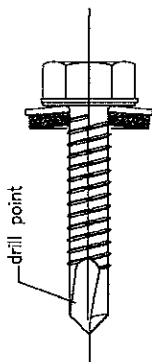

self-drilling screw
with sealing washer

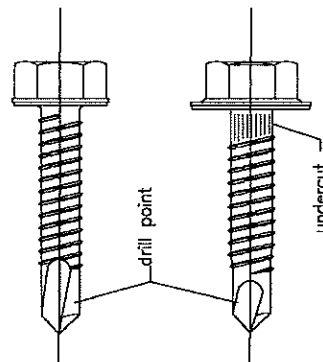

self-drilling screw
with integrated washer

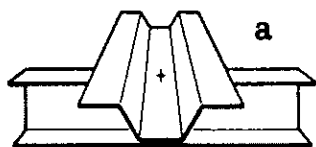

Single connection

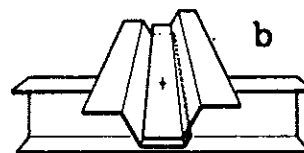

Side lap connection

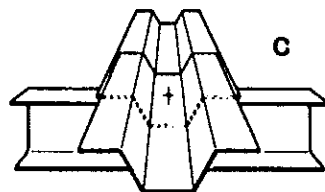

End overlap connection

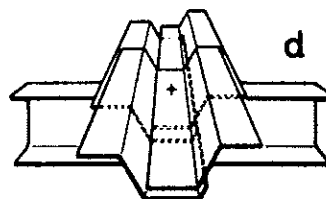

Side lap + end overlap connection

Screws

Examples for screws
Types of connection

Annex 1

of European Technical Approval
ETA-10/0183

Materials

Fastener: stainless steel (1.4301) - EN 10088
 Bi-metal

Washer: stainless steel (1.4301) - EN 10088

Component I: S280GD, S320GD or S350GD - EN 10346
 Component II: S280GD, S320GD or S350GD - EN 10346

Drilling capacity $\Sigma t_i \leq 2,00$ mm

Timber substructures

no performance determined

$t_{N,II}$ [mm]	0,40	0,50	0,55	0,63	0,75	0,88	1,00	1,13	1,25	1,50
$M_{t,nom}$	3 Nm					3,5 Nm				
$V_{R,k}$ [kN] for $t_{N,I}$ [mm]	0,40	0,57	0,71	0,77	0,86	1,05	1,05	1,05	1,05	1,05
	0,50	0,57	0,88	0,94	1,07	1,05	1,05	1,05	1,05	1,05
	0,55	0,57	0,88	1,11	1,17	1,20	1,20	1,20	1,20	—
	0,63	0,57	0,88	1,11	1,34	1,34	1,34	1,34	1,34	—
	0,75	0,57	0,88	1,11	1,34	1,61	1,61	1,61	1,61	—
	0,88	0,57	0,88	1,11	1,34	1,61	2,01	2,01	—	—
	1,00	0,57	0,88	1,11	1,34	1,61	2,01	2,40	—	—
	1,13	0,57	0,88	1,11	1,34	1,61	—	—	—	—
	1,25	0,57	0,88	1,11	1,34	1,61	—	—	—	—
	1,50	0,57	0,88	—	—	—	—	—	—	—
	1,75	—	—	—	—	—	—	—	—	—
$N_{R,k}$ [kN] for $t_{N,I}$ [mm]	0,40	0,35	0,45	0,51	0,62	0,81	1,04	1,29	1,49	1,49
	0,50	0,35	0,45	0,51	0,62	0,81	1,04	1,29	1,49	1,49
	0,55	0,35	0,45	0,51	0,62	0,81	1,04	1,29	1,49	—
	0,63	0,35	0,45	0,51	0,62	0,81	1,04	1,29	1,49	—
	0,75	0,35	0,45	0,51	0,62	0,81	1,04	1,29	1,49	—
	0,88	0,35	0,45	0,51	0,62	0,81	1,04	1,29	—	—
	1,00	0,35	0,45	0,51	0,62	0,81	1,04	1,29	—	—
	1,13	0,35	0,45	0,51	0,62	0,81	—	—	—	—
	1,25	0,35	0,45	0,51	0,62	0,81	—	—	—	—
	1,50	0,35	0,45	—	—	—	—	—	—	—
	1,75	—	—	—	—	—	—	—	—	—

Self drilling screw OCWS-4,8 with hexagonal head and sealing washer $\geq \varnothing 14$ mm	Annex 2 of European technical approval ETA-10/0183
---	--

Materials

Fastener: stainless steel (1.4301) - EN 10088
 Bi-metal

Washer: stainless steel (1.4301) - EN 10088

Component I: S280GD, S320GD or S350GD - EN 10346

Component II: S235 or S275 - EN 10025-1
 S280GD, S320GD or S350GD - EN 10346

Drilling capacity $\Sigma t_i \leq 6,00$ mm

Timber substructures

no performance determined

$t_{N,II}$ [mm]	1,00	1,13	1,25	1,50	1,75	2,00	2,50	3,00
$M_{t,nom}$	3 Nm			4 Nm				
$V_{R,k}$ [kN] for $t_{N,I}$ [mm]	0,50	1,30	1,30	1,30	1,30	1,30	1,30	1,30
	0,55	1,36	1,36	1,36	1,36	1,36	1,36	1,36
	0,63	1,45	1,68	1,91	1,91	1,91	1,91	1,91
	0,75	1,69	1,88	2,08	2,13	2,18	2,18	2,18
	0,88	1,90	2,08	2,26	2,36	2,47	2,63	2,87
	1,00	2,11	2,24	2,42	2,59	2,74	3,08	3,57
	1,13	2,11	2,24	2,42	2,71	2,99	3,40	4,13
	1,25	2,11	2,24	2,42	2,83	3,23	3,72	4,70
	1,50	2,11	2,24	2,42	2,83	3,23	3,72	4,70
	1,75	2,11	2,24	2,42	2,83	3,23	3,72	4,70
	2,00	2,11	2,24	2,42	2,83	3,23	3,72	4,70
$N_{R,k}$ [kN] for $t_{N,I}$ [mm]	0,50	0,80	1,06	1,29	1,67	1,67	1,67	1,67
	0,55	0,80	1,06	1,29	1,79	1,92	1,92	1,92
	0,63	0,80	1,06	1,29	1,79	2,30	2,32	2,32
	0,75	0,80	1,06	1,29	1,79	2,30	2,81	2,93
	0,88	0,80	1,06	1,29	1,79	2,30	2,81	3,61
	1,00	0,80	1,06	1,29	1,79	2,30	2,81	3,85
	1,13	0,80	1,06	1,29	1,79	2,30	2,81	3,85
	1,25	0,80	1,06	1,29	1,79	2,30	2,81	3,85
	1,50	0,80	1,06	1,29	1,79	2,30	2,81	3,85
	1,75	0,80	1,06	1,29	1,79	2,30	2,81	3,85
	2,00	0,80	1,06	1,29	1,79	2,30	2,81	3,85

Self drilling screw OCWS-5,5 with hexagon head and sealing washer $\geq \varnothing 16$ mm	Annex 3 of European technical approval ETA-10/0183
---	--

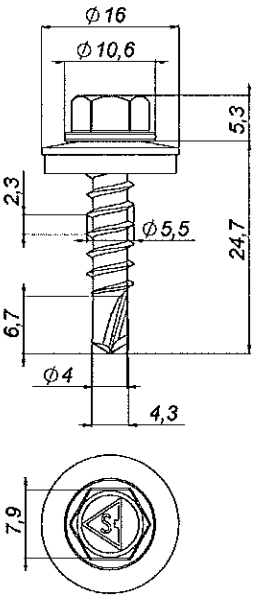

Materials
 Fastener: stainless steel (1.4301) - EN 10088
 Bi-metal
 Washer: stainless steel (1.4301) - EN 10088
 Component I: S280GD, S320GD or S350GD - EN 10346
 Component II: S280GD, S320GD or S350GD - EN 10346

Drilling capacity $\Sigma t_i \leq 6,00$ mm

Timber substructures
 no performance determined

$t_{N,II}$ [mm]	2 x 0,63	2 x 0,75	2 x 0,88	2 x 1,00	—	—	—	—
$M_{t,nom}$	5 Nm				—			
$V_{R,k}$ [kN] for $t_{N,I}$ [mm]	0,50	1,17	1,17	1,17	1,17	—	—	—
	0,55	1,17	1,17	1,17	1,17	—	—	—
	0,63	1,17	1,47	1,47	1,47	—	—	—
	0,75	1,17	1,47	1,60	1,74	—	—	—
	0,88	1,17	1,47	1,60	1,74	—	—	—
	1,00	1,17	1,47	1,60	1,74	—	—	—
	1,13	1,17	1,47	1,60	1,74	—	—	—
	1,25	1,17	1,47	1,60	1,74	—	—	—
	1,50	1,17	1,47	1,60	1,74	—	—	—
	1,75	1,17	1,47	1,60	1,74	—	—	—
2,00	1,17	1,47	1,60	1,74	—	—	—	
$N_{R,k}$ [kN] for $t_{N,I}$ [mm]	0,50	1,03	1,41	1,67	1,67	—	—	—
	0,55	1,03	1,41	1,90	1,92	—	—	—
	0,63	1,03	1,41	1,90	2,32	—	—	—
	0,75	1,03	1,41	1,90	2,42	—	—	—
	0,88	1,03	1,41	1,90	2,42	—	—	—
	1,00	1,03	1,41	1,90	2,42	—	—	—
	1,13	1,03	1,41	1,90	2,42	—	—	—
	1,25	1,03	1,41	1,90	2,42	—	—	—
	1,50	1,03	1,41	1,90	2,42	—	—	—
	1,75	1,03	1,41	1,90	2,42	—	—	—
2,00	1,03	1,41	1,90	2,42	—	—	—	

Self drilling screw

OCWS-5,5
 with hexagon head and sealing washer $\geq \varnothing 16$ mm

Annex 4
 of European technical approval
ETA-10/0183

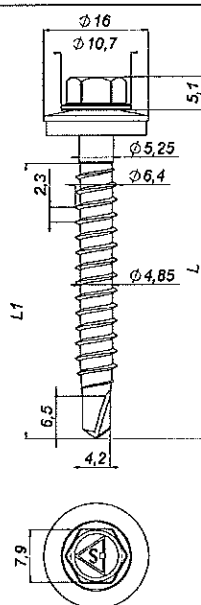

Materials

Fastener: stainless steel (1.4301) - EN 10088
 Bi-metal
 Washer: stainless steel (1.4301) - EN 10088
 Component I: S280GD, S320GD or S350GD - EN 10346
 Component II: S235 or S275 - EN 10025-1
 S280GD, S320GD or S350GD - EN 10346

Drilling capacity $\Sigma t_i \leq 6,00$ mm

Timber substructures

performance determined with

$M_{y,Rk} = 9,742$ Nm
 $f_{ax,k} = 11,070$ N/mm² for $l_{ef} \geq 25,0$ mm

$t_{N,II}$ [mm]	1,50	2,00	2,50	3,00	4,00	5,00	---		
$M_{t,nom}$	5 Nm							---	
$V_{R,k}$ [kN] for $t_{N,I}$ [mm]	0,40	1,02	1,02	1,02	1,02	1,02	1,02	1,02	
	0,50	1,34	1,34	1,34	1,34	1,34	1,34	1,34	
	0,55	1,47	1,47	1,47	1,47	1,47	1,47	1,47	
	0,63	1,71	1,71	1,71	1,71	1,71	1,71	1,71	
	0,75	2,23	2,23	2,23	2,23	2,23	2,23	2,23	
	0,88	2,86	2,86	2,86	2,86	2,86	2,86	2,86	
	1,00	3,52	3,52	3,52	3,52	3,52	3,52	3,52	
	1,13	3,52	3,52	3,52	3,52	3,52	---	3,52	
	1,25	3,52	3,52	3,52	3,52	---	---	3,52	
	1,50	3,52	3,52	3,52	3,52	---	---	3,52	
	1,75	3,52	3,52	3,52	3,52	---	---	3,52	
$N_{R,k}$ [kN] for $t_{N,I}$ [mm]	0,40	1,18	1,18	1,18	1,18	1,18	1,18	1,18	
	0,50	1,67	1,67	1,67	1,67	1,67	1,67	1,67	
	0,55	1,92	1,92	1,92	1,92	1,92	1,92	1,92	
	0,63	2,32	2,32	2,32	2,32	2,32	2,32	2,32	
	0,75	2,80	2,80	2,80	2,80	2,80	2,80	2,93	
	0,88	2,80	2,80	2,80	2,80	2,80	2,80	3,61	
	1,00	2,80	2,80	2,80	2,80	2,80	2,80	4,25	
	1,13	2,80	2,80	2,80	2,80	---	---	4,25	
	1,25	2,80	2,80	2,80	2,80	---	---	4,25	
	1,50	2,80	2,80	2,80	2,80	---	---	4,25	
	1,75	2,80	2,80	2,80	2,80	---	---	4,25	

The values listed above in dependence on the screw-in length l_{ef} are valid for $k_{mod} = 0,90$ and timber strength grade C24 ($\rho_a = 350$ kg/m³). For other combinations of k_{mod} and timber strength grades see section 4.2.2.

Self drilling screw

ODWS-6,5
 with hexagon head and sealing washer $\geq \varnothing 16$ mm

Annex 5

of European technical approval

ETA-10/0183

Materials

Fastener: stainless steel (1.4301) - EN 10088
 Bi-metal

Washer: stainless steel (1.4301) - EN 10088

Component I: S280GD, S320GD or S350GD - EN 10346

Component II: S235 or S275 - EN 10025-1
 S280GD, S320GD or S350GD - EN 10346

Drilling capacity $\Sigma t_i \leq 6,00$ mm

Timber substructures
 no performance determined

$t_{N,II}$ [mm]	2 x 0,63	2 x 0,75	2 x 0,88	2 x 1,00	—	—	—	—	
$M_{t,norm}$	4 Nm				—				
$V_{R,k}$ [kN] for $t_{N,I}$ [mm]	0,50	1,23	1,23	1,23	1,23	—	—	—	—
	0,55	1,23	1,23	1,23	1,23	—	—	—	—
	0,63	1,23	1,51	1,51	1,51	—	—	—	—
	0,75	1,23	1,51	1,83	2,15	—	—	—	—
	0,88	1,23	1,51	1,83	2,15	—	—	—	—
	1,00	1,23	1,51	1,83	2,15	—	—	—	—
	1,13	1,23	1,51	1,83	2,15	—	—	—	—
	1,25	1,23	1,51	1,83	2,15	—	—	—	—
	1,50	1,23	1,51	1,83	2,15	—	—	—	—
	1,75	1,23	1,51	1,83	2,15	—	—	—	—
2,00	1,23	1,51	1,83	2,15	—	—	—	—	
$N_{R,k}$ [kN] for $t_{N,I}$ [mm]	0,50	0,98	1,33	1,66	1,67	—	—	—	—
	0,55	0,98	1,33	1,66	1,92	—	—	—	—
	0,63	0,98	1,33	1,66	1,93	—	—	—	—
	0,75	0,98	1,33	1,66	1,93	—	—	—	—
	0,88	0,98	1,33	1,66	1,93	—	—	—	—
	1,00	0,98	1,33	1,66	1,93	—	—	—	—
	1,13	0,98	1,33	1,66	1,93	—	—	—	—
	1,25	0,98	1,33	1,66	1,93	—	—	—	—
	1,50	0,98	1,33	1,66	1,93	—	—	—	—
	1,75	0,98	1,33	1,66	1,93	—	—	—	—
2,00	0,98	1,33	1,66	1,93	—	—	—	—	

Self drilling screw OCS-5,5 with hexagon head and sealing washer $\geq \varnothing 16$ mm	Annex 7 of European technical approval ETA-10/0183
--	--

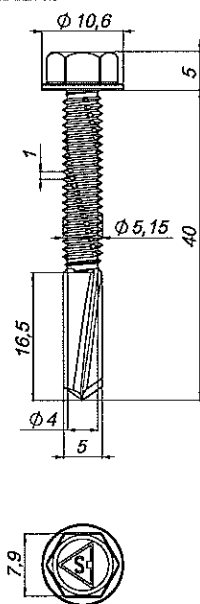

Materials

Fastener: stainless steel (1.4301) - EN 10088
 Bi-metal
 Washer: stainless steel (1.4301) - EN 10088
 Component I: S280GD, S320GD or S350GD - EN 10346
 Component II: S235 or S275 - EN 10025-1
 S280GD, S320GD or S350GD - EN 10346

Drilling capacity $\Sigma t_i \leq 12,00$ mm

Timber substructures

no performance determined

$t_{N,II}$ [mm]	4,00	5,00	6,00	7,00	8,00	9,00	10,0	11,0	
$M_{t,nom}$	7 Nm								
$V_{F,k}$ [kN] for $t_{N,I}$ [mm]	0,50	1,38	1,38	1,38	1,38	1,38	1,38	1,38	1,38
	0,55	1,53	1,53	1,53	1,53	1,53	1,53	1,53	1,53
	0,63	1,85	1,85	1,85	1,85	1,85	1,85	1,85	1,85
	0,75	2,18	2,18	2,18	2,18	2,18	2,18	2,18	2,18
	0,88	2,76	2,76	2,76	2,76	2,76	2,76	2,76	2,76
	1,00	3,22	3,22	3,22	3,22	3,22	3,22	3,22	3,22
	1,13	3,55	3,55	3,55	3,55	3,55	3,55	3,55	3,55
	1,25	3,90	5,87	5,87	5,87	5,87	5,87	5,87	5,87
	1,50	4,53	6,63	6,63	6,63	6,63	6,63	6,63	6,63
	1,75	5,05	7,39	7,39	7,39	7,39	7,39	7,39	7,39
	2,00	5,45	8,16	8,16	8,16	8,16	8,16	8,16	8,16
$N_{F,k}$ [kN] for $t_{N,I}$ [mm]	0,50	1,67	1,67	1,67	1,67	1,67	1,67	1,67	1,67
	0,55	1,92	1,92	1,92	1,92	1,92	1,92	1,92	1,92
	0,63	2,32	2,32	2,32	2,32	2,32	2,32	2,32	2,32
	0,75	2,93	2,93	2,93	2,93	2,93	2,93	2,93	2,93
	0,88	2,96	3,30	3,30	3,30	3,30	3,30	3,30	3,30
	1,00	2,96	3,30	3,30	3,30	3,30	3,30	3,30	3,30
	1,13	2,96	3,30	3,30	3,30	3,30	3,30	3,30	3,30
	1,25	2,96	3,30	3,30	3,30	3,30	3,30	3,30	3,30
	1,50	2,96	3,30	3,30	3,30	3,30	3,30	3,30	3,30
	1,75	2,96	3,30	3,30	3,30	3,30	3,30	3,30	3,30
	2,00	2,96	3,30	3,30	3,30	3,30	3,30	3,30	3,30

Self drilling screw

ONS-5,5
 with hexagon head and sealing washer $\geq \varnothing 16$ mm

Annex 8

of European technical approval

ETA-10/0183

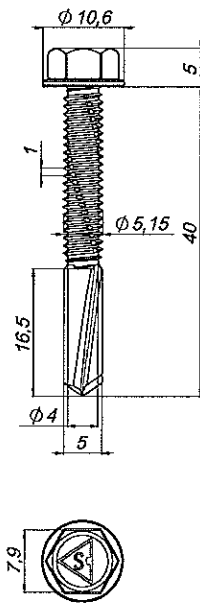

Materials

Fastener: stainless steel (1.4301) - EN 10088
 Bi-metal

Washer: none

Component I: S280GD, S320GD or S350GD - EN 10346

Component II: S235 or S275 - EN 10025-1
 S280GD, S320GD or S350GD - EN 10346

Drilling capacity $\Sigma t \leq 12,00$ mm

Timber substructures

no performance determined

$t_{N,II}$ [mm]	4,00	5,00	6,00	7,00	8,00	9,00	10,0	11,0	
$M_{t,nom}$	7 Nm								
$V_{R,k}$ [kN] for $t_{N,I}$ [mm]	0,50	1,38	1,38	1,38	1,38	1,38	1,38	1,38	1,38
	0,55	1,53	1,53	1,53	1,53	1,53	1,53	1,53	1,53
	0,63	1,85	1,85	1,85	1,85	1,85	1,85	1,85	1,85
	0,75	2,18	2,18	2,18	2,18	2,18	2,18	2,18	2,18
	0,88	2,76	2,76	2,76	2,76	2,76	2,76	2,76	2,76
	1,00	3,22	3,22	3,22	3,22	3,22	3,22	3,22	3,22
	1,13	3,55	3,55	3,55	3,55	3,55	3,55	3,55	3,55
	1,25	3,90	5,87	5,87	5,87	5,87	5,87	5,87	5,87
	1,50	4,53	6,63	6,63	6,63	6,63	6,63	6,63	6,63
	1,75	5,05	7,39	7,39	7,39	7,39	7,39	7,39	7,39
	2,00	5,45	8,16	8,16	8,16	8,16	8,16	8,16	8,16
$N_{R,k}$ [kN] for $t_{N,I}$ [mm]	0,50	1,40	1,40	1,40	1,40	1,40	1,40	1,40	1,40
	0,55	1,57	1,57	1,57	1,57	1,57	1,57	1,57	1,57
	0,63	1,81	1,81	1,81	1,81	1,81	1,81	1,81	1,81
	0,75	2,09	2,09	2,09	2,09	2,09	2,09	2,09	2,09
	0,88	2,09	2,09	2,09	2,09	2,09	2,09	2,09	2,09
	1,00	2,09	2,09	2,09	2,09	2,09	2,09	2,09	2,09
	1,13	2,09	2,09	2,09	2,09	2,09	2,09	2,09	2,09
	1,25	2,09	2,09	2,09	2,09	2,09	2,09	2,09	2,09
	1,50	2,09	2,09	2,09	2,09	2,09	2,09	2,09	2,09
	1,75	2,09	2,09	2,09	2,09	2,09	2,09	2,09	2,09
	2,00	2,09	2,09	2,09	2,09	2,09	2,09	2,09	2,09

Self drilling screw

ONS-5,5
 with hexagon head

Annex 9

of European technical approval

ETA-10/0183